

MEASURING PROBES AND DIGITAL DISPLAYS

Sylvac proposes three types of probe depending on the area of measurement applications.

Digital absolute probes:

- Ultra-high precision
- Direct USB output or M8

Capacitive probes:

- Measuring range up to 25mm
- High-precision measurement across the range of the probe
- Very good repeatability
- Reduction of intrinsic error if coupled to the SYLVAC display units

Inductive probes:

- Small footprint and very good repeatability
- Ideal for multi-dimension applications of 2 to 255 probes

SYLVAC display units connect a wide range of products such as Sylvac linear probes, linear rulers, handtools and digital indicators.

Absolute capacitive measuring system

Digital display units RS232 and USB

Operational temperature 0 to +50°C



Measuring probes

LISTING OF ALL MODELS

	INDUCTIVE				CAPACITIVE							
	TYPE	P2i	P2iP	P5i	P5iP	P5	P5BL	P5V	P5B	P5BVL	P5L	P5VL
	ORDER NUMBER	900.1101	900.1102	900.1111	900.1112	900.1001	900.1002	900.1003	900.1004	900.1007	900.1006	900.1008
RANGE												
±2 mm		•	•									
5 mm						•	•	•	•		•	•
± 5 mm				•	•							
10 mm												
12.7 mm												
25 mm												
EXECUTION												
Plain bearing						•		•			•	•
B- Ball bearing		•	•	•	•		•		•	•		
Pneumatic push			•		•							
V- Vacuum lifter								•		•		•
L- 90 degrees cable		*		*			•			•	•	•
S- with rubber boot		•	•	•	•	•	•	•	•	•	•	•
MECHANIC												
Diameter 8 mm h6		•	•	•	•	•	•	•	•	•	•	•
Diameter 12 mm												
Measuring anvil M2.5		•	•	•	•	•	•	•	•	•	•	•
LIFTING												
Integrated			•		•			•		•		•
Separate accessories						•	•		•		•	
PROTECTION IP												
Protection rating IP (IEC 60529)		65	65	65	65	64	64	64	64	64	64	64

* by accessories, see next pages

Absolute digital measuring probes

P12D

DESCRIPTION

- Very high accuracy P12D probes Series, available in 3 different versions :
 - High Accuracy
 - Standard
 - Work : for workshop (details on the following pages)
- Measuring range 12.7mm (1/2in)
- Resolution up to 0.01 μm
- Repeatability up to 0.08 μm
- Absolute system with integrated correction, no more pairing needed
- Patented dual inductive and capacitive system
- Available in very low force version
- USB connector or M8 industrial connector



H

Absolute digital measuring probes

P12D

DIMENSIONAL DRAWINGS

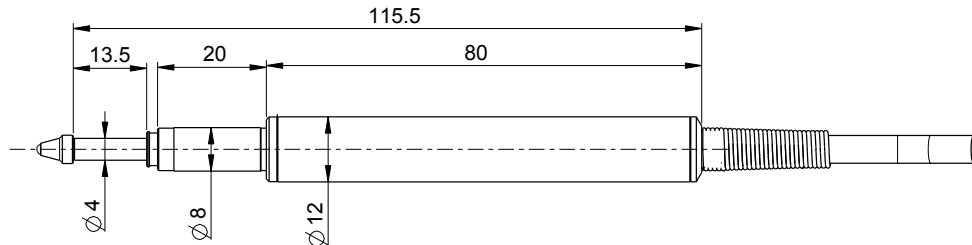

TECHNICAL SPECIFICATIONS

High resolution		801.1012	801.1018	801.1212	801.1218
Resolution type		High resolution			
Type		P12D HR USB	P12D HR USB CF ²⁾	P12D HR M8	P12D HR M8 CF ²⁾
Force ¹⁾	N	0.2 - 0.3	0.08	0.2 - 0.3	0.08
Measuring range	mm	12.7			
Resolution	µm	0.01			
Max. Error	µm	0.6			
Repeatability	µm	0.08			
Nb measures/s		up to 100/s, according to configuration ⁵⁾			
Output data		USB		M8	
Cable output		Straight			

Standard resolution		801.2012	801.2017	801.2212
Resolution type		Standard		
Type		P12D USB	P12D USB LF ³⁾	P12D M8
Force ¹⁾	N	0.4 - 0.8	0.2 - 0.3	0.4 - 0.8
Measuring range	mm	12.7		
Resolution	µm	0.1		
Max. Error	µm	1		
Repeatability	µm	0.2		
Nb measures/s		up to 100/s, according to configuration ⁵⁾		
Output data		USB		M8
Cable output		Straight		

¹⁾ ± 20%, vertical position

²⁾ CF = constant force : usable only vertically, rod pointing downwards (without spring)

³⁾ LF = low force

⁴⁾ depends on resolution and software

⁵⁾ depends on resolution and number of probes

P12D - special version

P12D WORK

DESCRIPTION

- Special version of our P12D probes for workshop
- Measuring range 12.7mm (½in)
- Resolution 0.1 µm
- Repeatability 0.2 µm
- Absolute system with integrated correction, no more pairing needed
- Patented dual inductive and capacitive system
- USB connector or M8 industrial connector

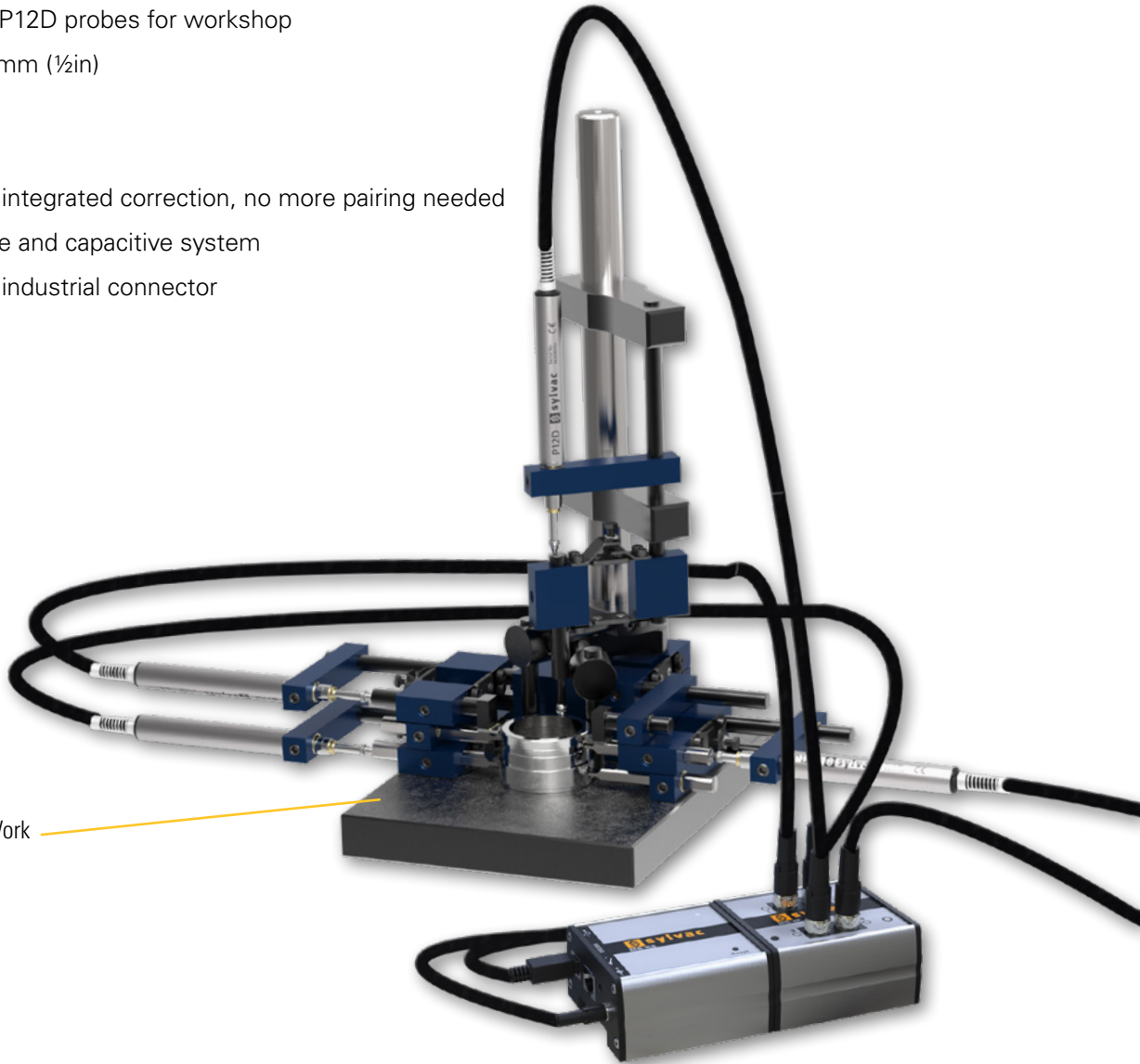

Jig with P12D Work

SWISS MADE IP54

Standard resolution		801.0212	801.0012
Resolution type		Standard	
Type		P12D WORK M8	P12D WORK USB
Force ¹⁾	N	0.4 - 0.8	
Measuring range	mm	12.7	
Resolution	µm	0.1	
Max. Error	µm	1.8	
Repeatability	µm	0.2	
Nb measures/s		up to 100/s, according to configuration ¹⁾	
Output data		M8	USB
Cable output		Straight	

¹⁾ depends on resolution and number of probes

H

Absolute digital measuring probes

P12D

STANDARD DELIVERY

- Probe according to technical specifications
- Cable 1.8 m
- Stainless steel contact point with tungsten carbide ball \varnothing 2 mm
- Quickstart
- Calibration certificate

APPLICATIONS



Probe P12D USB connected to a PC, measures displayed by Sylcom.



Probe P12D USB connected to a D300S (maximum resolution 0.1µm)



Probes P12D M8 connected to a D62S.

Inductive measuring probes

DESCRIPTION

- Inductive measuring probes specially designed for measurement by comparison
- Available in 2 versions: spring push and pneumatic push
- Long life precision bearing guidance (tested up to 13 million cycles)
- Resolution <math><0.0001\text{ mm}</math>
- Repeatability $0.15\text{ }\mu\text{m}$
- Measuring range $\pm 2\text{ mm}$ and $\pm 5\text{ mm}$
- Compatible with D300SV2, D70i and D400S units through M-Bus multiplexer units
- High data speed
- Operating temperature $+5$ to $+80^{\circ}\text{C}$
- IP65 protected

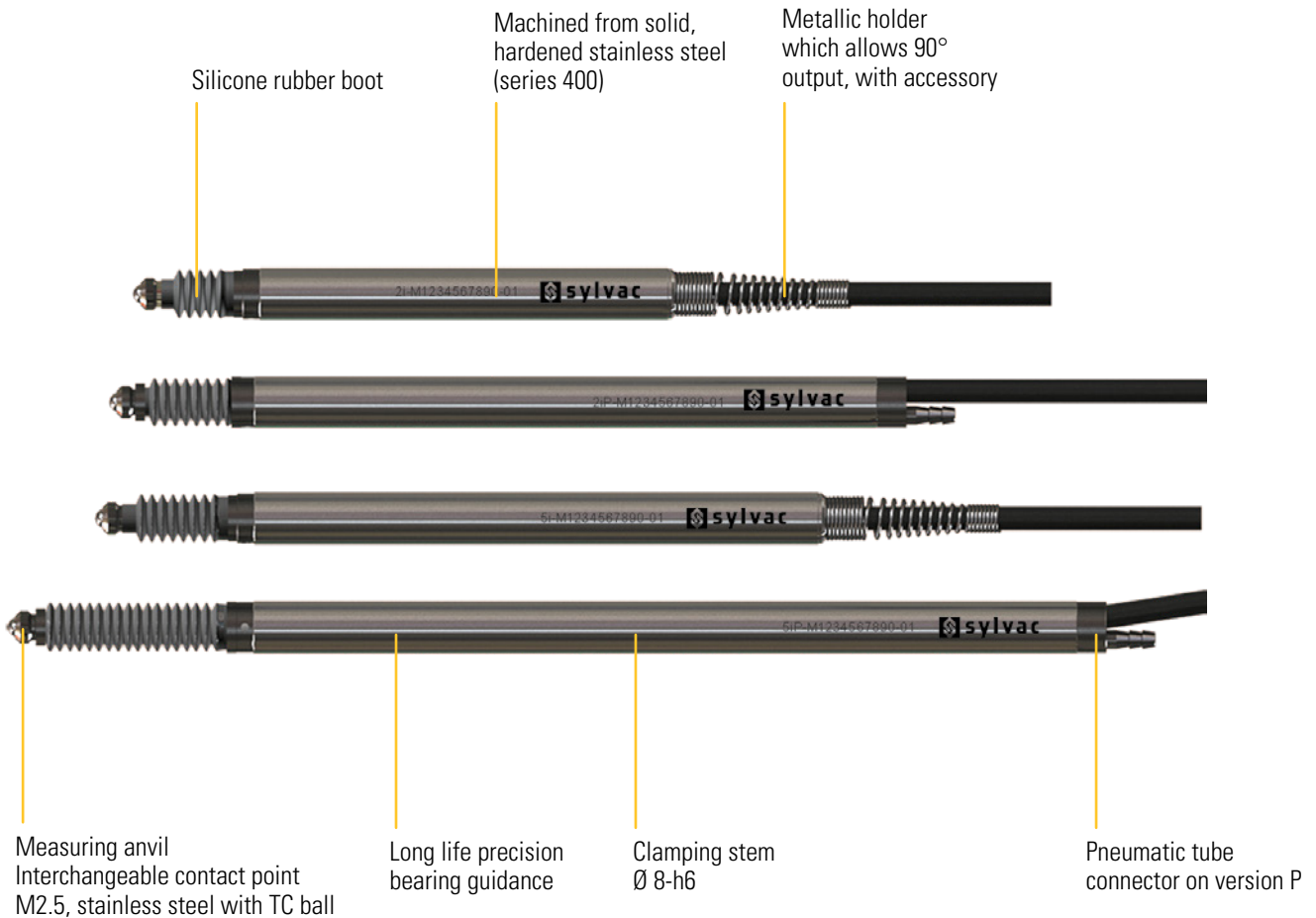

IP65

Inductive measuring probes

DIMENSIONAL DRAWINGS

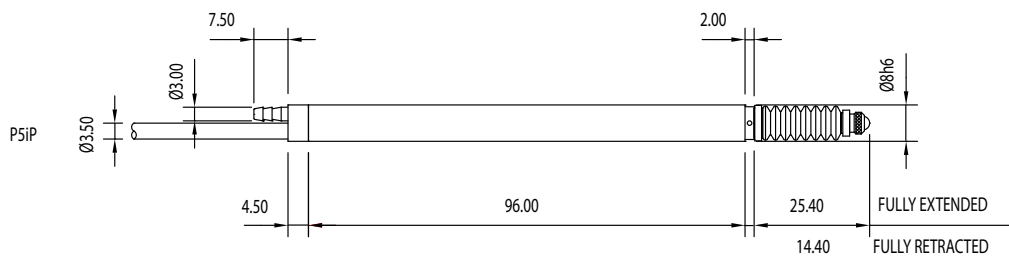
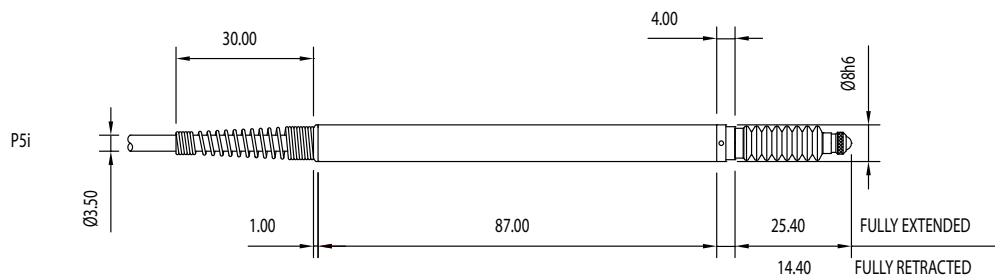
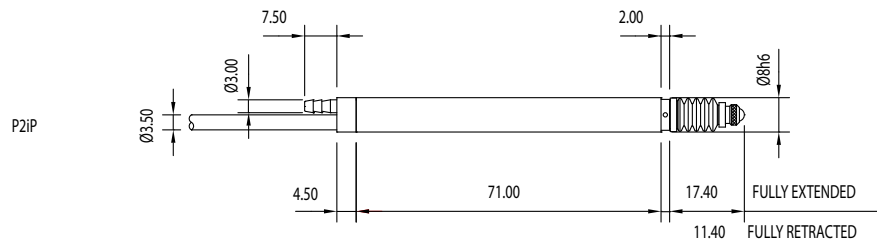
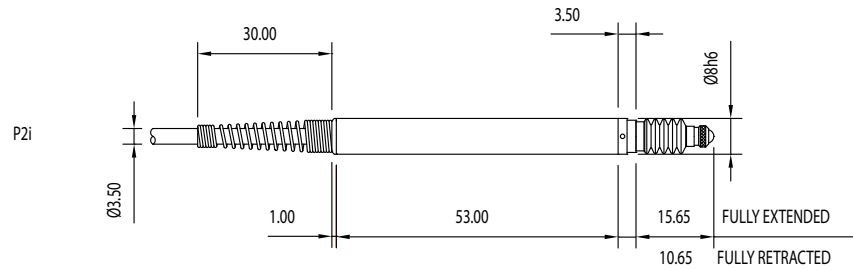

Inductive measuring probes

TECHNICAL SPECIFICATIONS

		P2i	P2iP	P5i	P5iP
Travel	mm	±2	±2	±5	±5
Pre-travel	mm	0.15	0.8	0.15	0.3
Post-travel	mm	1.35	1.2	0.85	0.7
Resolution		Digital : user selectable to <0.1µm			
Repeatability	µm	0.15	0.15	0.15	0.15
Moving mass	g	3.4	3.4	3.7	3.7
Accuracy of reading %		0.5	0.5	0.5	0.5
Body diameter	mm	8h6			
IP rating		IP65			
Temperature	%FS/°C	0.01			

MEASURING FORCE

		P2i	P2iP	P5i	P5iP
Standard	N	0.7	0.7 / 0.4 bar - 2.6 / 1 bar	0.7	0.7 / 0.4 bar - 2.6 / 1 bar

Tolerance ± 20%, measuring probe in middle course, outgoing spindle.

PNEUMATIC PROBES

Pneumatic probes are fully retracted when they are not supplied with air. For continual reliable operation and to maximise working life, the air supply should be clean and dry. 60% maximum relative humidity, filtered to better than 2µm particle size. Air pressure : 0.4-0.8 bar, don't go over 0.8 Bar because the rubber boot can be damaged.

LIST OF REFERENCES

P2i				P5i			
P2i	900.1101	P2iP	900.1102	P5i	900.1111	P5iP	900.1112

P = pneumatic push

Inductive measuring probes

STANDARD DELIVERY

- Probe according to technical specifications
- Cable 2 m
- Stainless steel contact point with tungsten carbide ball \varnothing 3 mm (905.2204)
- Calibration certificate

APPLICATIONS



Inductives probes connected to a D70I.



Inductives and Solartron probes connected to a M-Bus modul coupled with D400S.



Inductives probes connected to a M-Bus modul coupled with D300S.

Capacitive measuring probes

DESCRIPTION

- Capacitive absolute measuring probes, plunger type
- Resolution 0.0001 mm
- Measuring range from 5 to 25 mm
- Plain bearing or ball bearing, integrated vacuum lifter on P5
- Compatible with all Sylvac digital units
- Excellent linearity
- Interchangeable cables on most types

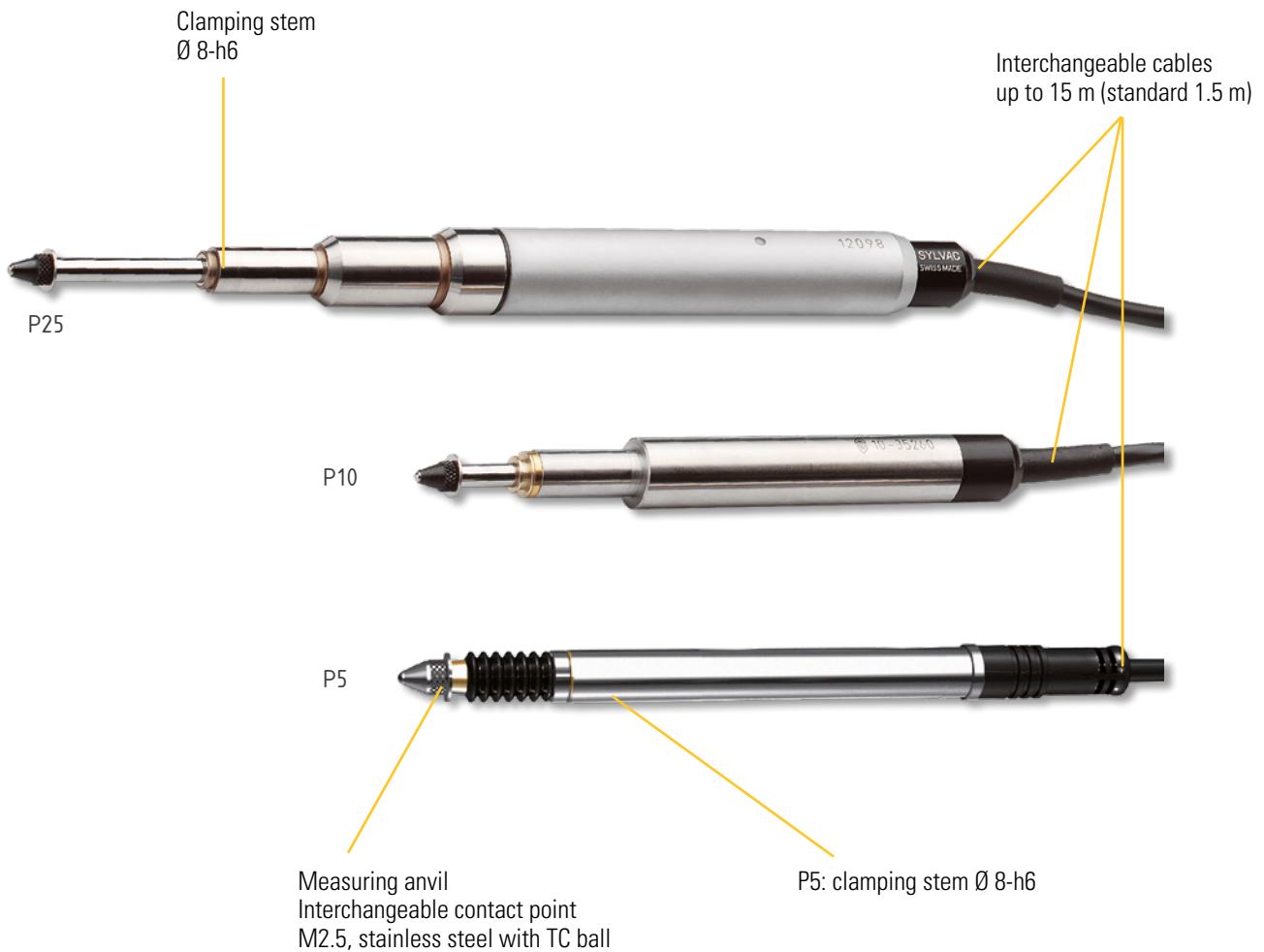

Capacitive measuring probes

DIMENSIONAL DRAWINGS

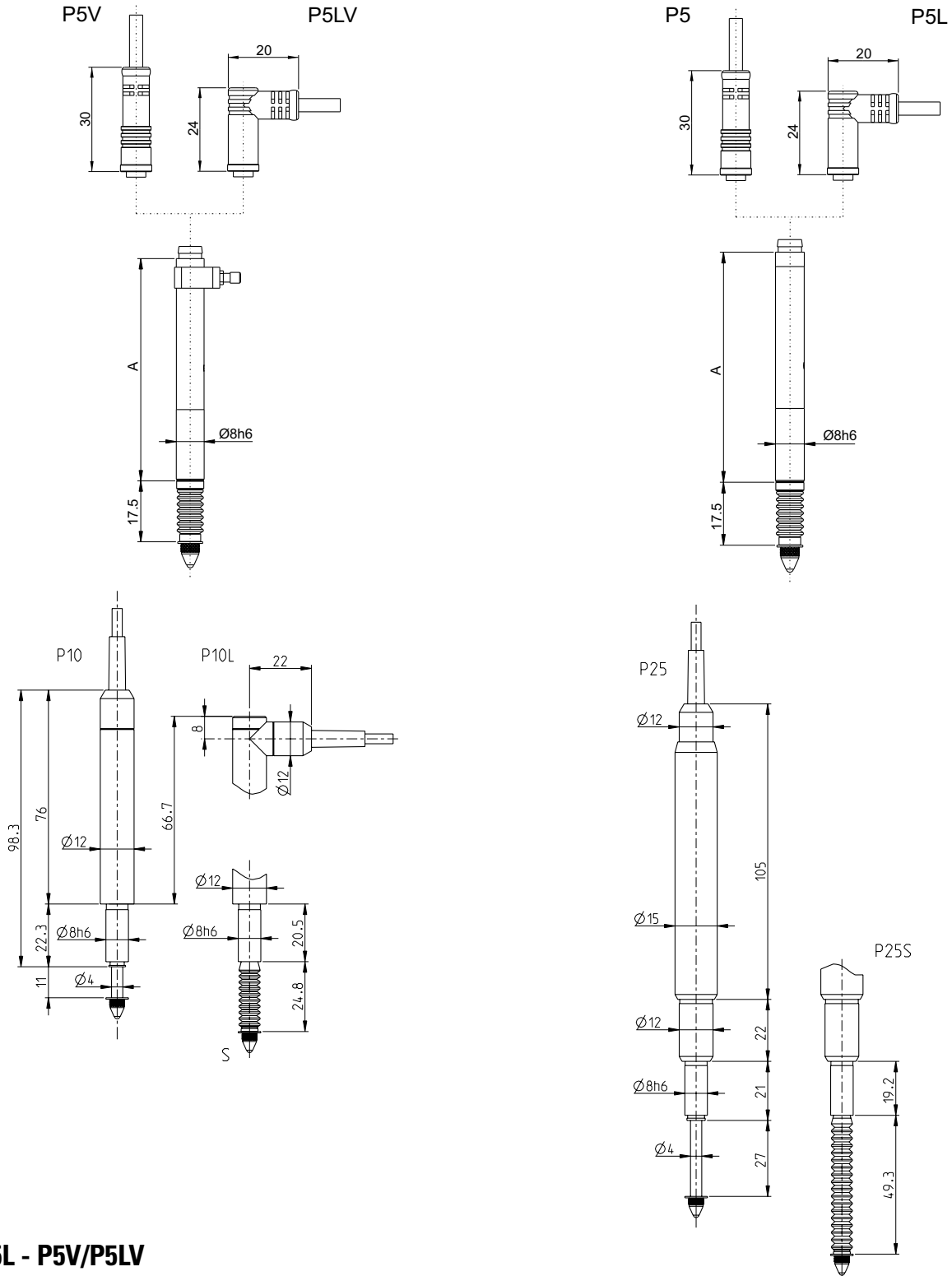

P5/P5L - P5V/P5LV

Guiding axis	Measure A
Plain bearing	72
Ball bearing	64

Capacitive measuring probes

TECHNICAL SPECIFICATIONS

		P5	P10	P25
Travel	mm	5	10	25
Pre-travel	mm	0.7	0.5	0.8
Max. Error ¹⁾	µm	1	1	1.2
Repeatability	µm	0.2	0.2	0.2
Moving mass	g	3.7	4.1	9.6

¹⁾ With Master unit. See as well the specifications of the pair Measuring probe/display unit.

MEASURING FORCE

		P5	P5B	P10	P10S	P25	P25S
Standard	N	0.50-0.90	0.50-0.90	0.60-0.80	0.70-1.25	0.60-1.00	0.65-1.4
Minimum	N	0.20-0.25*	0.25-0.50	< 0.10	---	< 0.15	---
Low	N	0.30-0.65	0.30-0.65	0.20-0.25	---	0.20-0.30	---
High	N	0.80-1.40	---	0.70-1.50	---	0.70-1.60	---

Tolerance $\pm 20\%$, measuring probe in vertical position, outgoing spindle.

* without rubber boot

LIST OF REFERENCES

P5				P10				P25			
P5	900.1001	P5BV	900.1005	P10	900.1010	P10L LF	900.1014.91	P25	900.1025	P25S	900.1027
P5BL	900.1002	P5L	900.1006	P10 LF	900.1010.91						
P5V	900.1003	P5BVL	900.1007	P10S	900.1012	P10LS	900.1016				
P5B	900.1004	P5LV	900.1008	P10L	900.1014						

B = ball bearing / V = Vacuum lifter / L = 90° cable / LF = low force / S = with rubber boot

STANDARD DELIVERY

- Probe according to technical specifications
- Calibration certificate
- Cable 1.5 m
- Stainless steel contact point with tungsten carbide ball $\varnothing 2$ mm (905.2204)

Capacitive measuring probes

APPLICATIONS



P5 probes connected to a D302 coupled with D300S for OD, concentricity and cylindricity measurements



P5 probes connected to a D50S unit measuring the external diameter of a shaft

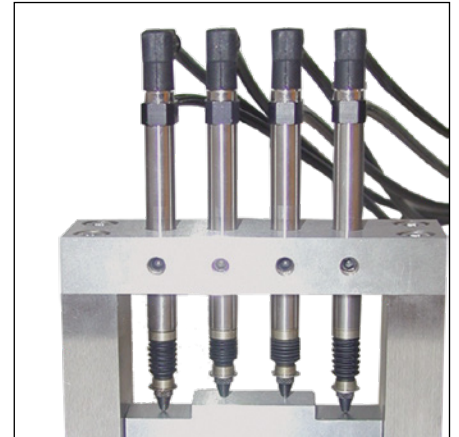

Combined probes for the measurement of several heights



Capacitive probes connected to a D70S.

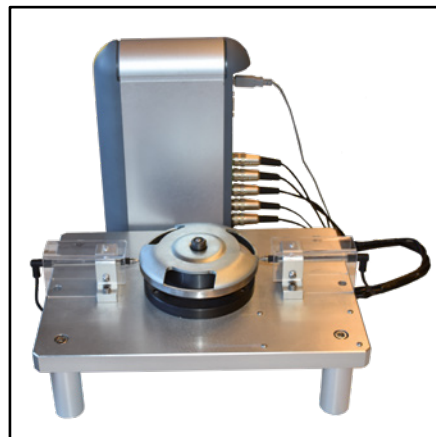

Capacitive probes connected to a D200S



Capacitive probes on a jig

Measuring probes

ACCESSORIES

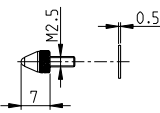
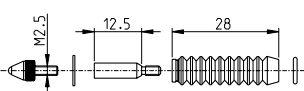
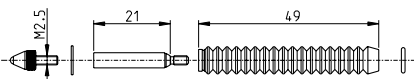
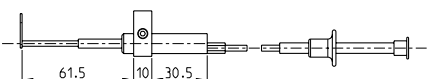
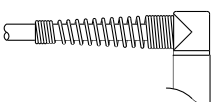
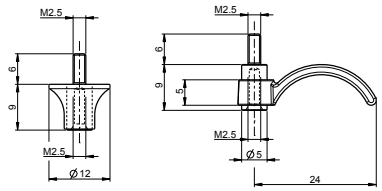
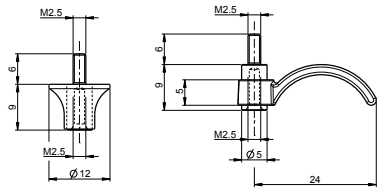
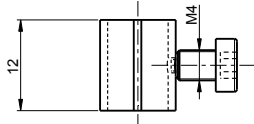
		P2i	P2iP	P5i	P5iP	P2	P5	P10	P25	P12D
	905.2204					•	•	•	•	•
	901.2003							•		
	901.2004								•	
	901.2005							•	•	•
	901.2012						•	•	•	
	901.2013						•	•	•	
	901.2014						•	•	•	
	901.5110	•		•						
	905.2225	•	•	•	•	•	•	•	•	•
	905.2224	•	•	•	•	•	•	•	•	•
	905.2231	•	•	•	•	•	•	•	•	•

H





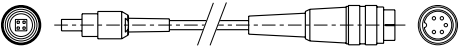
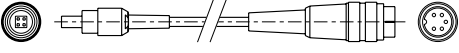
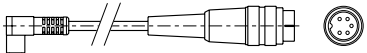
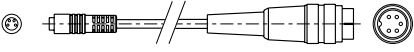
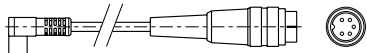
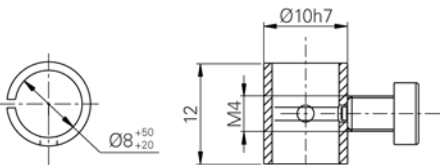
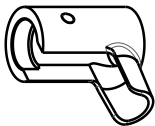

Measuring probes

ACCESSORIES

		P2i	P2iP	P5i	P5iP	P2	P5	P10	P25	P12D
	901.5002 Cable 1.5 m							•		
	901.5012 Cable 1.5 m								•	
	901.5032 Cable 1.5 m bent							•		
	901.5042 Cable 1.5 m						•			
	901.5052 Cable 1.5 m bent						•			
	905.2231 Adapting socket + screw	•	•	•	•	•	•	•	•	•
	801.5101 Bridle 90°									•

Digital display

TABLE OF CORRESPONDENCES

							
		D50S	D50S PRO	D62S	D62S Adv.	D70S	D70H
Direct input	Probes	2 ^{c)}	2 ^{c)}	2 ^{a)}	2 ^{a)}	2 ^{c)}	2 ^{H)}
	RS/USB instruments						
	External contact	1	1	1	2	1 ^{p)}	1 ^{p)}
	Mbus						
	Air gages						
	Instrument with Bluetooth® technology						
Additional input	Probes						
	USB instruments						
	Analog display			•	•	•	•
Output	RS 232	•	•	•	•	•	•
	RS 485						
	USB			• ¹⁰⁾	• ¹⁰⁾	• ¹⁰⁾	• ¹⁰⁾
	Opto-coupled output						
	Analogic						
	Bluetooth® technology (slave)				•		
Functions	Direct zero setting	•	•	•	•	•	•
	Direct zero setting per channel	•	•	•	•	•	•
	Selection of resolution	•	•	•	•	•	•
	Selection of measuring direction	•	•	•	•	•	•
	PRESET	•	•	•	•	•	•
	Tolerance indicators			•	•	•	•
	Classification (max 8 classes)				•	• ¹¹⁾	• ¹¹⁾
	Min, Max, Delta				•	•	•
	A ± B (predifined functions)	•	•	•	•	•	•
	Mathematics functions				•		
	Scanning of the channels					•	•
	Histogram						
	Statistics						
	Memorization				•		
	Simultaneous display of the channels			•	•	•	•
	Dynamic measurement				•	•	•
	Calibration (max. 25 points)		•			•	
Time and date display					•		
Battery					•		

¹⁾ with unit (s) additional (s) D108

²⁾ with 3 D200S units

³⁾ 32 probes with units D200S or maximum 32 with D302 / D304 or M-Bus

⁴⁾ with USB-Hub powered

⁵⁾ depending on model, see details on pages D300S

⁶⁾ with modul MB-IO









⁷⁾ with dongle Smart for D300S & MB-BT for D400S

⁸⁾ A± B± C± D±, depending on model

⁹⁾ Maximum 99 instruments on D400S through M-BUS (MB-4D & MB-8D digimatic)

Digital display

TABLE OF CORRESPONDENCES

 D70I	 D70A	 D200S	 D300S^{*)}	 D302	 D302 a	 D304	 D304 a	 D400S
2 ⁱ⁾		8 ^{c)}	2(4) ^{c)} 1/6	2 ^{c)}	2 ^{c)}	4 ^{c)}	4 ^{c)}	
1 ^{p)}	1 ^{p)}	1	2 ● ⁵⁾	1	1	1	1	1 ●
	2		● ⁷⁾					● ⁷⁾
		24 ²⁾	32 ³⁾ 6 ⁴⁾					99 ⁹⁾ 99 ⁹⁾
●	●							●
●	●	●	●					●
● ¹⁰⁾	● ¹⁰⁾	●	●	●	●	●	●	●
		●	●					● ⁶⁾
					●		●	
●	●	●	●					●
●	●	●	●					●
●	●	●	●	●	●	●	●	●
●	●	●	●	●	●	●	●	●
● ¹¹⁾	● ¹¹⁾		●					● ¹¹⁾
●	●	●	●	●	●	●	●	●
●	●	●	●	●	●			● ¹²⁾
●	●	●	●			● ⁸⁾	● ⁸⁾	●
●	●		●					●
			●					●
		●	●					●
●	●	●	●					●
●	●	●	●	●	●	●	●	●
●		●	●					●

¹⁰⁾ Mini-USB

¹²⁾ Model 2018

¹¹⁾ Up to 16 classes for 1 channel only

^{p)} Binder 3 poles for D70S and D62S or Jack for D70H, D70A and D70I

^{c)} capacitive, ^{H)} Heidenhain, ⁱ⁾ inductive, ^{a)} absolute digital

* Maximum 62 mixed on the D300S instruments

Digital display

D50S

DESCRIPTION

- Digital display with 2 probe inputs
- Data output RS232C
- Power supply by external unit
- Light and compact
- Ease of use
- Correction of linearity on both channels (D50S PRO)

Resolution up to 0.0001 mm

Great clear and luminous display

Combination of channels A+B; A-B



Direct functions

Feet

Output cable RS232 to USB (925.1142), RS232 (925.5609) or Digimatic (926.8116)



D50S PRO

Correction of linearity.
Higher precision

IP40

SWISS MADE

RS232

Digital display

D50S

DISPLAY

- 1 Conversion mm/inch
- 2 Selection of resolution
- 3 Selection of measuring direction
- 4 REL and ABS measurement
- 5 PRESET function
- 6 Data sending
- 7 Selection of measuring mode: channel 1 ; channel 2 ; channel 1-2 ; channel 1+2



- 8 Probe inputs
- 9 Power supply connection
- 10 External contact connection
- 11 RS232 input/output

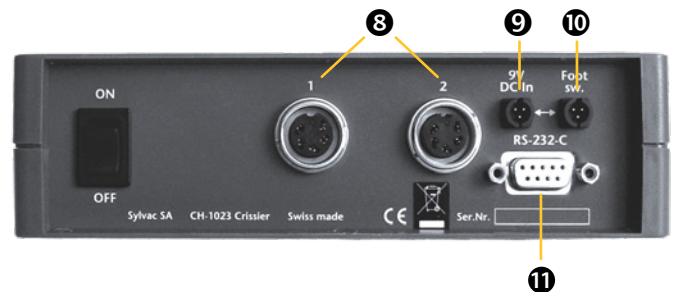

TECHNICAL SPECIFICATIONS

		804.1050	804.1060
Type		D50S	D50S PRO
Max. Error	µm	P2 : 1.5 / P5 : 1.6 / P10 : 1.6 / P25 : 1.9	P2 : 0.5 / P5 : 0.6 / P10 : 0.6 / P25 : 0.8
Repeatability	µm	P2 : 0.2 / P5 : 0.2 / P10 : 0.2 / P25 : 0.2	P2 : 0.2 / P5 : 0.2 / P10 : 0.2 / P25 : 0.2
Overall dimensions	mm	180 x 75 x 50	180 x 75 x 50
Weight	kg	0.3	0.3
Case		Terblend Plastic	Terblend Plastic
Protection according to IEC 60529		IP40	IP40
Output data		RS232 / USB / Digimatic ²⁾	RS232 / USB / Digimatic ²⁾
Programmable by PC		•	•

¹⁾ Max error on D50S PRO paired with a probe

²⁾ see cable chapter

STANDARD DELIVERY

- Unit according to technical specifications
- Feet (pair)
- Charging unit according to country (904.4200)
- Instruction manual

APPLICATIONS



Measuring a shaft with 2 probes (A+B)



PS15 with connected to a D50S



Simple measurement with one probe

COMBINATIONS OF PROBES

Diameter = 1+2

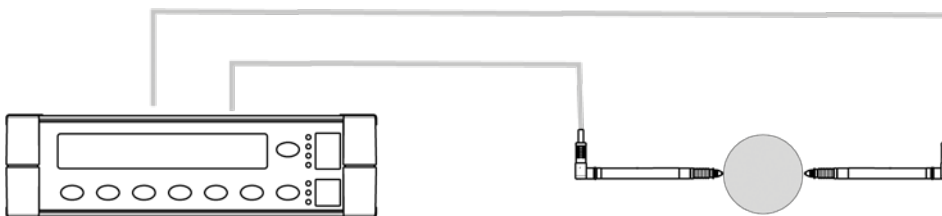

Difference = 1-2

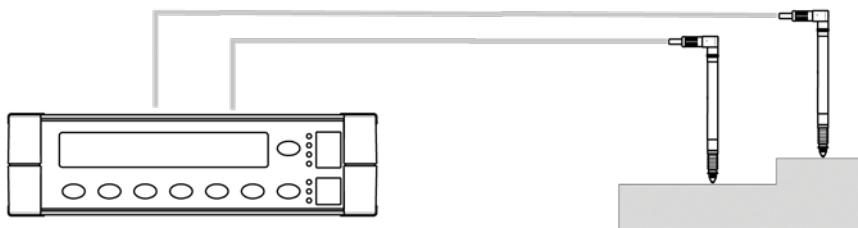

Individual measurement

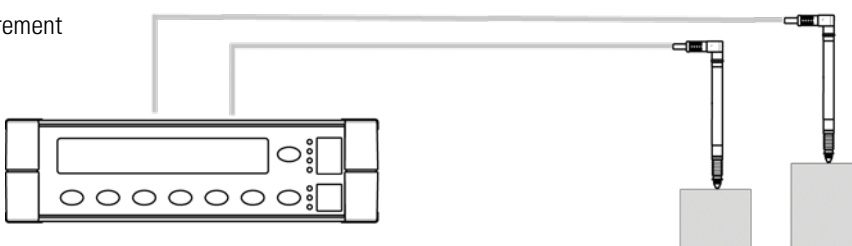

Digital display

D50S

POSSIBILITIES OF CONNECTION

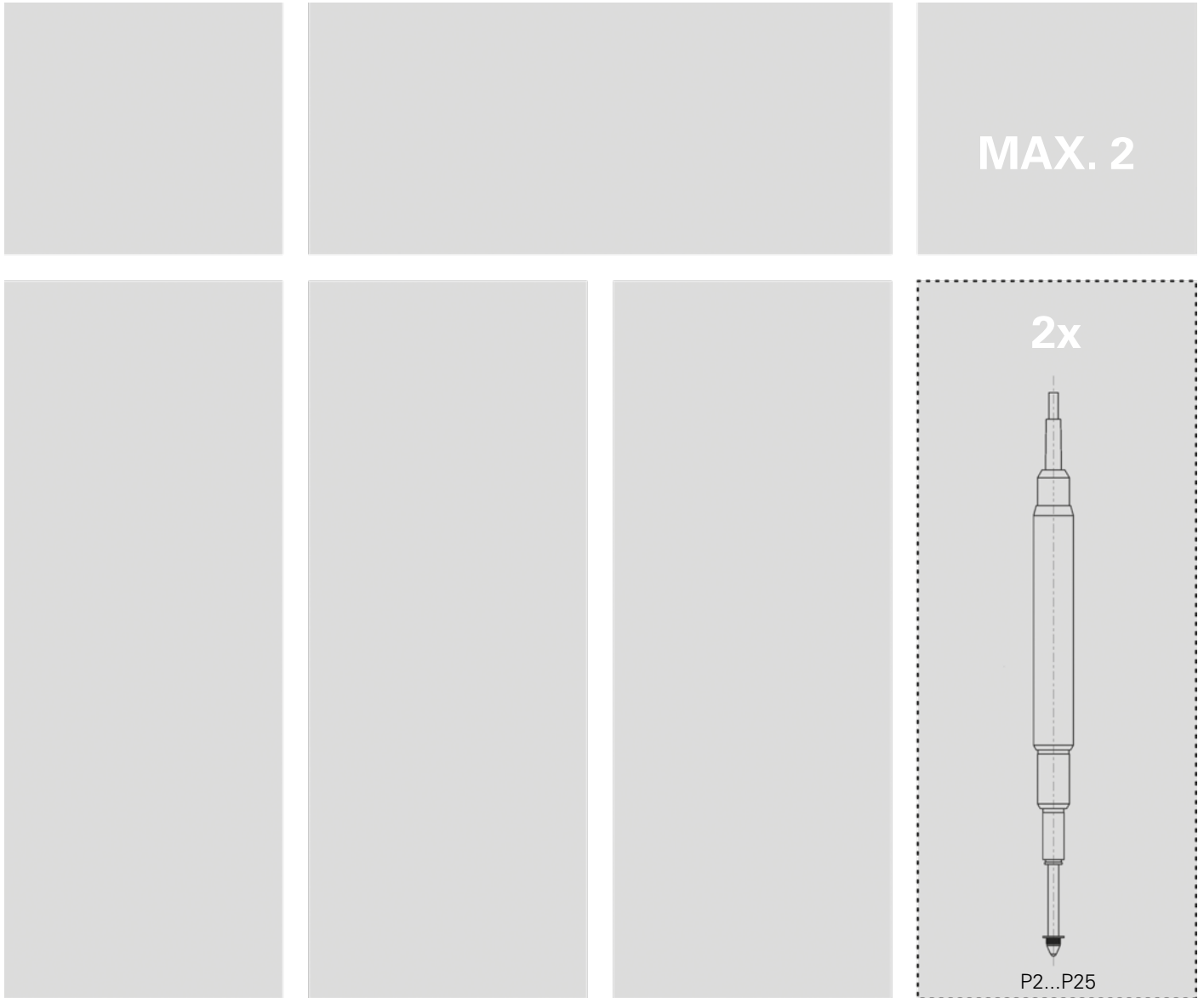

H

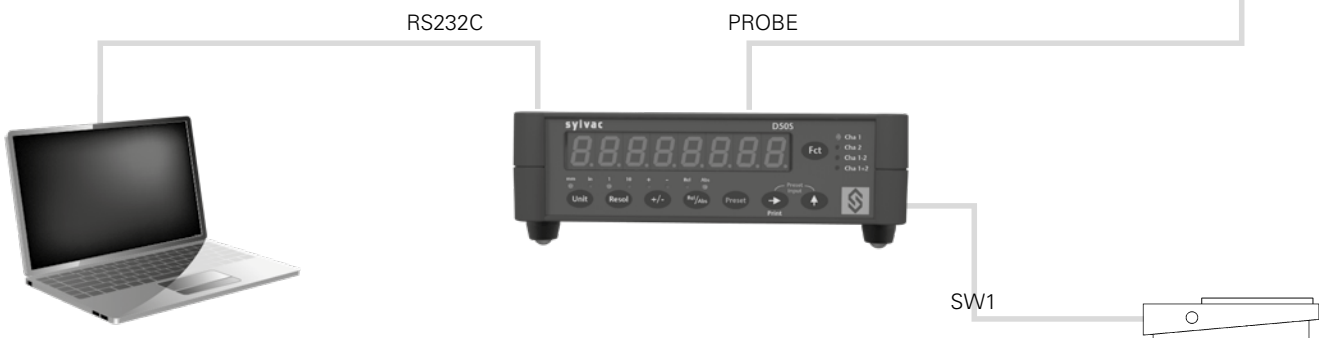

Digital display

D62S

DESCRIPTION

- New compact display unit exclusively for P12D probes with industrial connector M8
- 2x P12D probe inputs (M8)
- Innovative modern design
- Large touch screen display 4.3" with intuitive functions
- Shockproof construction
- Built-in battery autonomy 8 hours (depends on model)
- Indication of the global tolerance (depends on model)
- Data output RS232, USB or Bluetooth® technology (depends on model)
- Programmable by PC



H

IP54

(front face)

mini-USB

RS232



Output cable RS232 to RS232 (926.5609) or USB (925.1142) or output cable mini-USB sur USB (926.6001)

Digital display

D62S

DISPLAY

- 1 Menu display
- 2 Favourite key
- 3 SET
- 4 Selection of channels
- 5 Formula ¹⁾
- 6 Analog display
- 7 Current value, mode MIN/MAX/DELTA ¹⁾
- 8 Measuring mode MIN/MAX/DELTA ¹⁾
- 9 ON/OFF switch
- 10 Probe inputs (M8 - P12D)
- 11 RS232 inputs/outputs
- 12 Power-supply
- 13 mini/USB Device (PC connection)
- 14 Footswitch input
- 15 Light indicator of the global tolerances ¹⁾

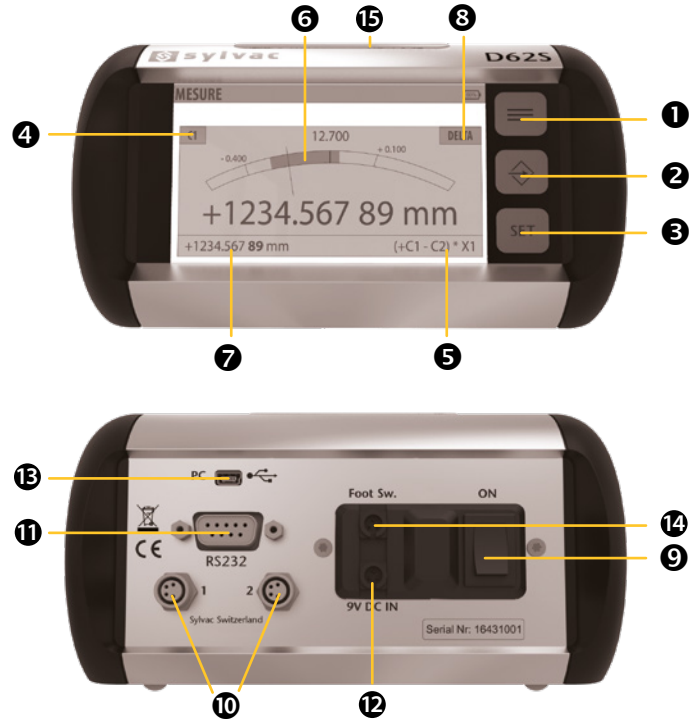

¹⁾ only on Advanced model

H

TECHNICAL SPECIFICATIONS

	804.1062	804.1063
Model	D62S	D62S Advanced
Inputs	2x M8 for Sylvac absolute digital probes	
Resolution	µm	0.01
Max. error	µm	P12D HR : 0.6
Repeatability	µm	P12D HR : 0.08
Overall dimensions	mm	170 x 90 x90
Weight	g	613
Case	Aluminium and thermoplastic elastomer	
Protection according to IEC 60529	IP40 (Front face : IP54)	
Output data	USB (Device) ¹⁾ , RS232	Bluetooth® wireless technology, RS232, USB (Device) ¹⁾
Indicator of the global tolerance		•
Battery		•
Time and date display (RTC)		•

²⁾ see cables chapter

Digital display

D62S

STANDARD DELIVERY

- Unit according to technical specifications
- Charging unit according to country (904.4200)
- Instruction manual

APPLICATIONS



Probes P12D connected to a D62S.



D62S Advanced sending data on the Sylvac Anywhere App for smartphones.

H

Digital display

D62S

POSSIBILITIES OF CONNECTION

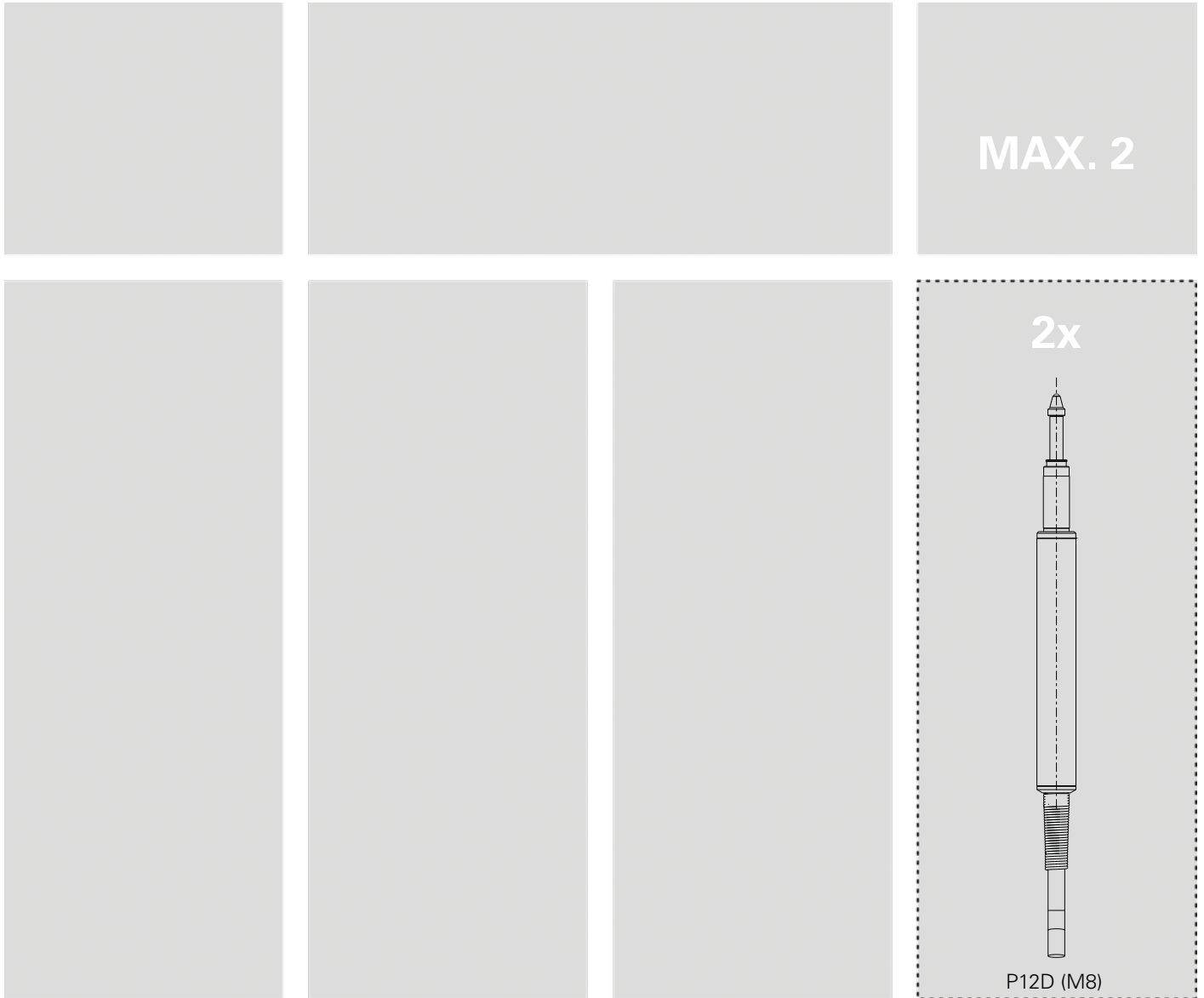

H

Digital display

D70S/H/I

DESCRIPTION

- 4"3 touch screen display
- Available in 3 versions:
 - D70S for Sylvac capacitive probes
 - D70I for Sylvac inductive probes (also compatible with Tesa and Mahr probes)
 - D70H for Heidenhain ST/MT probes (Mitutoyo and Magescale probes with adapter)
- All versions with 2 probes/instruments inputs
- Display resolution selectable up to 0.00001 mm (on D70H)
- Simple or double display with bargraph, needle or no-tolerances
- Probe's combination : (C1, C2, C1-C2 ...)
- Direct measurement or Min, Max, Average, Max-Min...
- User friendly interface
- Very robust construction (Aluminium)
- USB connection «Keyboard» unidirectional and RS232 bidirectional
- No driver, no software to be installed
- Compatibility Excel and SPC
- Powered by the computer when connected by USB cable

mini-USB

RS232

H

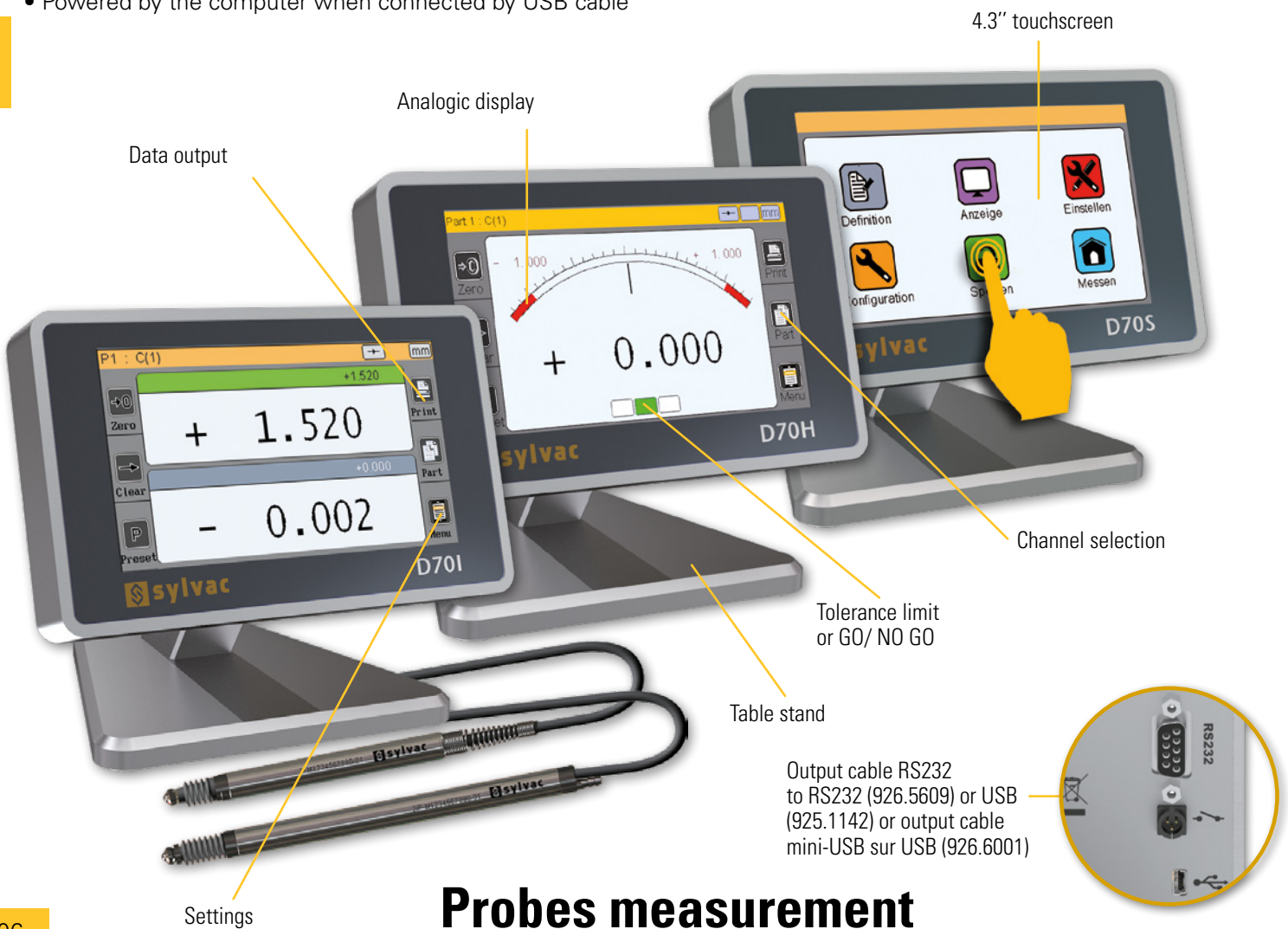

Probes measurement

Digital display

D70S/H/I

DISPLAY

- 1 4.3" Touchscreen display
- 2 User friendly interface
- 3 Analogic display
- 4 Digital display
- 5 ON/OFF
- 6 2 Capacitive / Inductive / 1VPP probes input (depending model)
- 7 RS232 output
- 8 1 external contact
- 9 Mini-usb and and supply/data
- 10 Input M-Bus / M8 (depending model)
- 11 Power-supply 24VDC (depending on model)

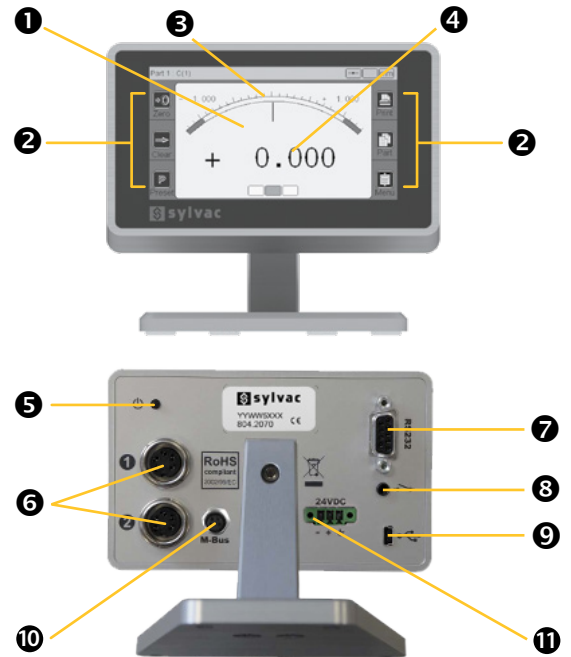

TECHNICAL SPECIFICATIONS

		804.2070
Type		D70S
Overall dimensions	mm	140x105x111
Weight	kg	0.6
Case		Aluminium
Protection according to IEC 60529		IP40
Output data		USB / RS232
Probes		Sylvac Capacitive probes
Programmable by PC		●

		804.2072
Type*		D70H
Overall dimensions	mm	140x105x111
Weight	kg	0.6
Case		Aluminium
Protection according to IEC 60529		IP40
Output data		USB / RS232 (1x1)
Probes		Heidenhain ST/MT probes (Mitutoyo & Magescale with adapter) / P12D
Programmable by PC		●

* Not available in Switzerland

Digital display

D70S/H/I

TECHNICAL SPECIFICATIONS

		804.2071
Type		D70I
Overall dimensions	mm	140x105x111
Weight	kg	0.6
Case		Aluminium
Protection according to IEC 60529		IP40
Output data		USB / RS232 (1x1)
Probes		Sylvac Inductive probes (Tesa & Mahr* compatible) / P12D
Programmable by PC		●

* Mahr probes : only probes compatible Tesa

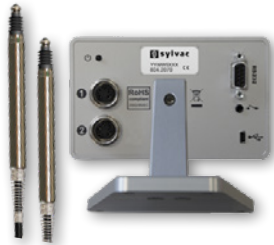

D70S : Capacitive probes



D70I : Inductive probes



D70H : Heidenhain probes

H

APPLICATIONS



D70S with capacitive Sylvac probes



D70H with Heidenhain probes



D70I with inductive probes

STANDARD DELIVERY

- Unit according to technical specifications
- Table base
- Charging unit
- Instruction manual

Digital display

D70S/H/I

POSSIBILITIES OF CONNECTION

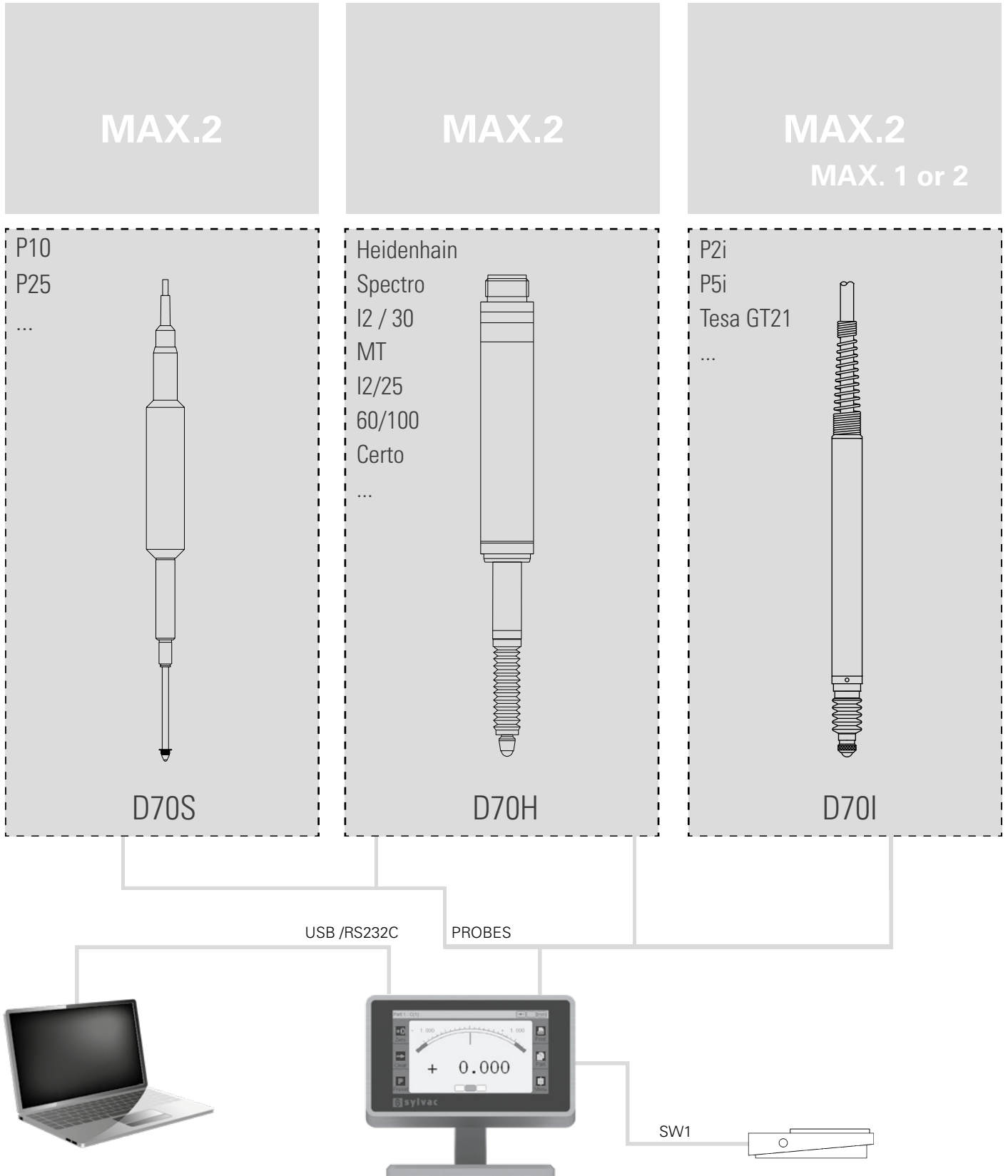

H

Digital display

D70A

DESCRIPTION

- 4"3 touch screen display
- Compatible with all brands of plug and air gages
- Available in 2 versions : 1 or 2 inputs
- Input for MB-IO
- Simple or double display with bargraph, needle or no-tolerances
- Direct measurement or Min, Max, Average, Max-Min...
- User friendly interface
- Very robust construction (Aluminium)
- USB connection «Keyboard» unidirectional and RS232 bidirectional
- No driver, no software to be installed
- Compatibility Excel and SPC
- Powered by the computer when connected by USB cable

mini-USB

Air measurement

RS232

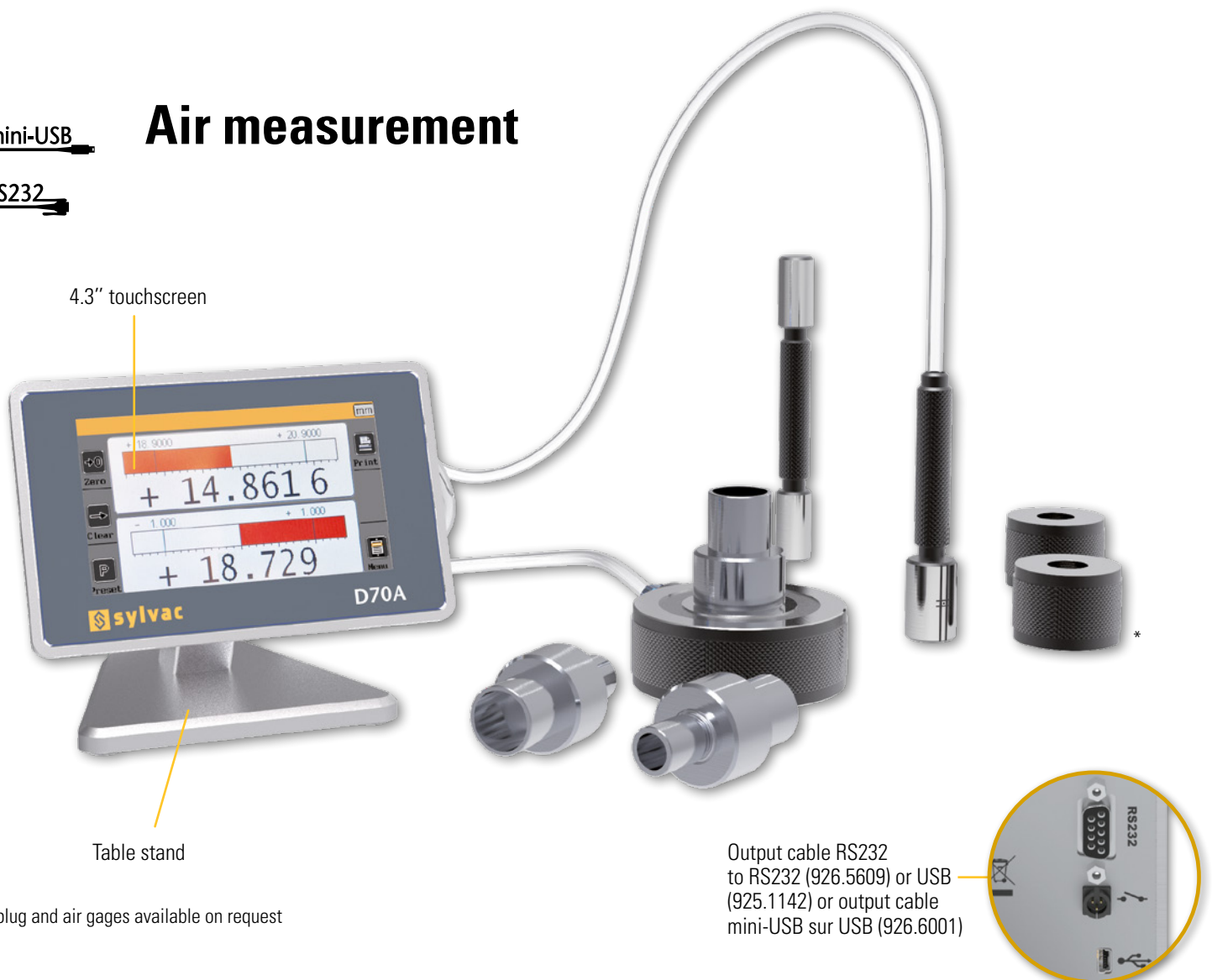

* plug and air gages available on request

Digital display

D70A

DISPLAY

- ① 4.3" Touchscreen display
- ② User friendly interface
- ③ Analogic display
- ④ Digital display
- ⑤ ON/OFF
- ⑥ 1 or 2 air gages inputs (depending model)
- ⑦ RS232 output
- ⑧ 1 external contact
- ⑨ Mini-usb and and supply/data
- ⑩ M-Bus Input
- ⑪ USB key input
- ⑫ Power-supply 24VDC

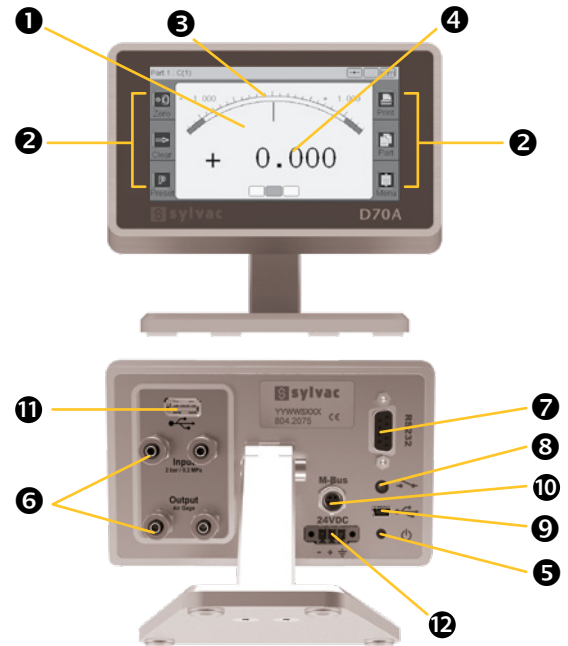

TECHNICAL SPECIFICATIONS

		804.2074
Type		D70A - 1 input
Overall dimensions	mm	140x105x111
Weight	kg	0.6
Case		Aluminium
Protection according to IEC 60529		IP40
Output data		USB / RS232
Instruments		Plug gages and air gages / P12D
Programmable by PC		●

		804.2075
Type*		D70A - 2 inputs
Overall dimensions	mm	140x105x111
Weight	kg	0.6
Case		Aluminium
Protection according to IEC 60529		IP40
Output data		USB / RS232 (1x1)
Instruments		Plug gages and air gages / P12D
Programmable by PC		●

Digital display

D70A

TECHNICAL SPECIFICATIONS

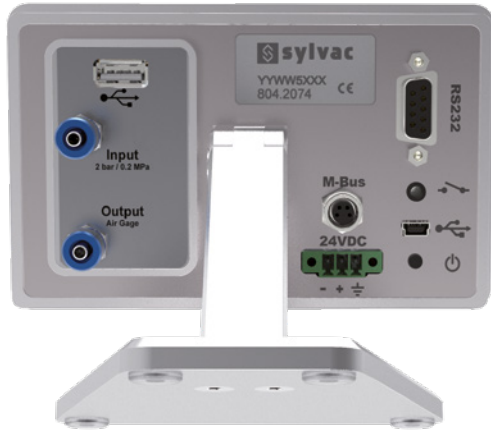

D70A - 1 input



D70A - 2 inputs

APPLICATIONS AND ACCESSORIES



D70A with air and plug gauges

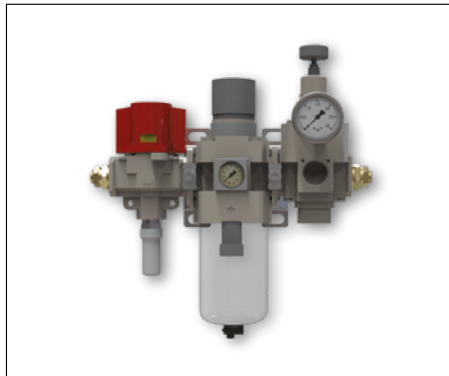

Air kit for D70A (804.2203)



D70A with accessory 804.2202 (panel mounting)

STANDARD DELIVERY

- Unit according to technical specifications
- Table base
- Charging unit
- Instruction manual
- 2 additional sets of restrictors

Digital display

D70A

POSSIBILITIES OF CONNECTION

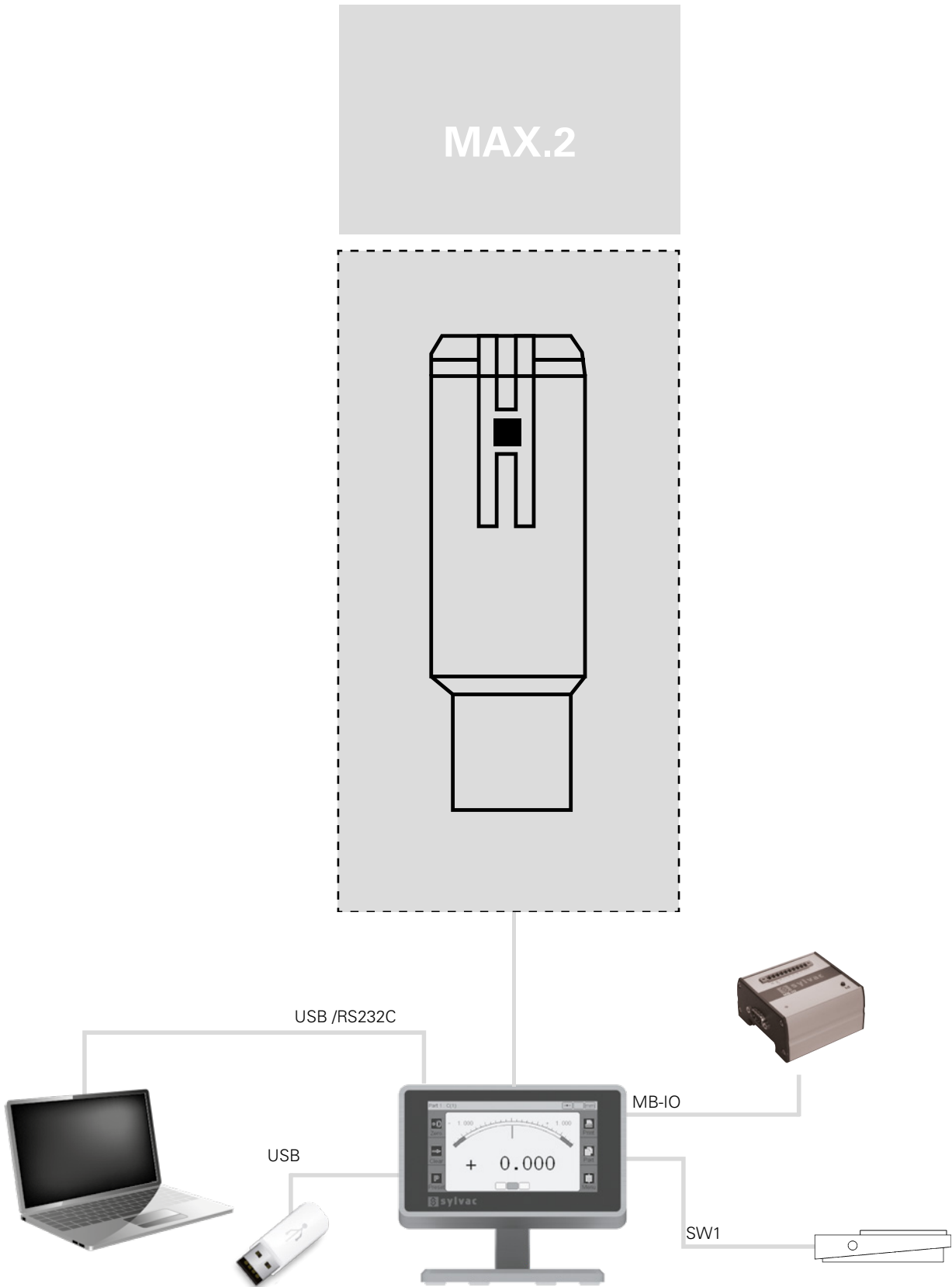

Multiplexer unit

D200S

DESCRIPTION

- Multiplexer with 8 inputs (for Sylvac probes P2 to P25)
- Dynamic measurement (200 mes/s)
- Ideal for the layout conception of multi-gauging
- Command for pneumatic lifting unit
- Software allowing the treatment of up to 24 channels simultaneously (bargraph)
- Sending of the measured values into Excel, notepad or in specific files
- Creation of sequences for sending data
- Mathematic combinations between channels
- Standalone use possible

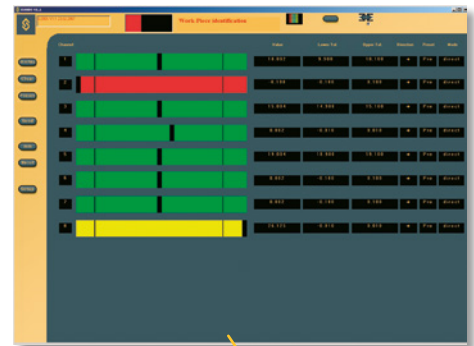

Output cable USB to USB (804.1210) or output cable RS232 to RS232 (925.5609)

8 inputs for Sylvac probes

Software allowing the treatment of up to 24 channels simultaneously (bargraph)

Tolerance indicators

Connection by USB (2x) or RS232 (1x)

Opto-coupled digital output rack

Connection by USB (2x) or RS232 (1x)

Multiplexer unit

D200S

DISPLAY/SOFTWARE

- Selection of unit mm/inch**
- Selection of resolution**
- PRESET function**
- Sending Data**
- Tolerance indicators with LED**
- Min/Max/Delta display**
- Individual selection of measuring direction**
- Switchable digital/bargraph display**
- Global tolerance status of the measured part**
- Programming channels screen**
- Sending Sequences of Data**
- External contact configuration**
- Electrical external contact configuration**
- Open / Save configurations**
- Transfer configuration to D200S unit**

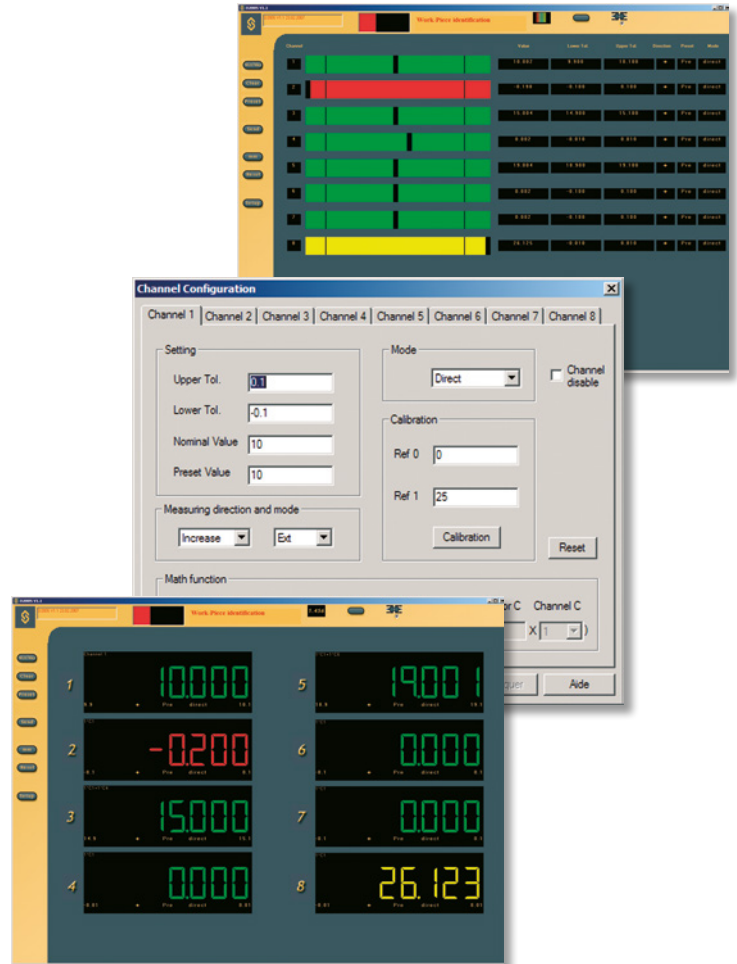

TECHNICAL SPECIFICATIONS

		804.1200
Type		D200S
Max. Error	µm	P2 : 1.5 / P5 : 1.6 / P10 : 1.6 / P25 : 1.9
Repeatability	µm	P2 : 0.2 / P5 : 0.2 / P10 : 0.2 / P25 : 0.2
Frequency of measurement		200 values /second
Overall dimensions	mm	304 x 171 x 61
Weight	kg	1.2
Case		Aluminium profile, Terlend plastic, ABS and aluminium vanished
Protection rating according to IEC 60529		IP50
Output data		USB / RS232 ¹⁾
Programmable by PC		•

¹⁾ see cables chapter

Multiplexer unit

D200S

STANDARD DELIVERY

- Instrument according to technical specifications
- Feet for use in vertical position
- Charging unit according to country (904.4200)
- PC Connection cable type USB (804.1210)
- CD with D200S software
- Instruction manual

APPLICATIONS



Dynamic measurement of several diameters, (OD and ID) of a shaft

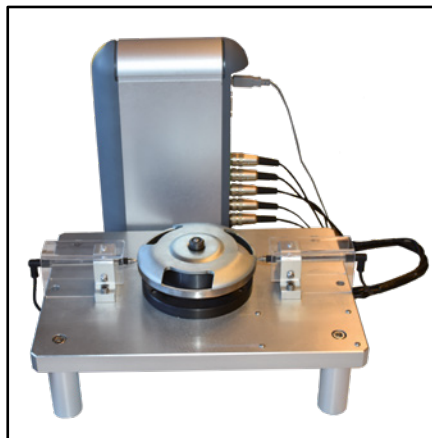

Capacitive probes connected to a D200S.



Multi-gauging application

H

Multiplexer unit

D200S

POSSIBILITIES OF D110V PNEUMATIC LIFTER

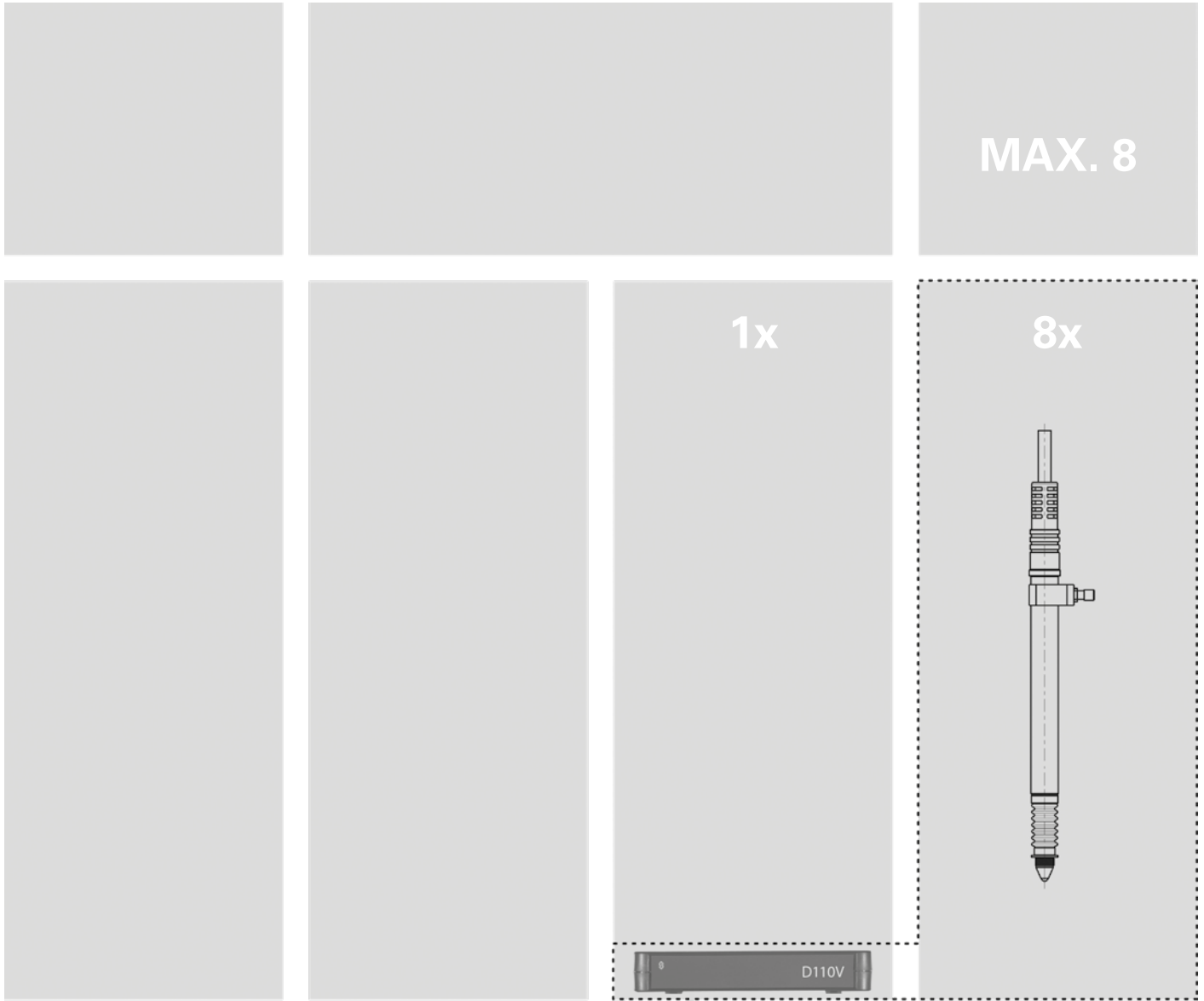

Multiplexer unit

D200S

POSSIBILITIES OF CONNECTION

MAX. 8

8x



P2...P25

MAX. 8

8x



P2...P25

MAX. 8

8x



P2...P25

H

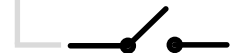
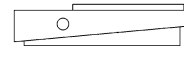
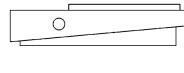
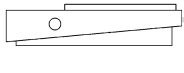

Digital display

D300S V2

DESCRIPTION

- Digital display with 8.5" touchscreen
- Available in 3 versions :
 - 6 USB and M-Bus
 - 6 USB and 2 Sylvac capacitive probe input
 - 6 USB and 4 Sylvac capacitive probe input
 - M-Bus and 2 Sylvac capacitive probe input
 - M-Bus and 4 Sylvac capacitive probe input
- Automatic detection of connected instruments
- CPU 5 times faster than previous version
- OS based on Windows CE 7 embedded
- Display and page setting fully configurable (up to 8 channels per page, up to 64 pages)
- Memorizing of setups and values
- RJ-45 Ethernet connector
- General or individual Preset
- Math functions for each channel
- Numeric, analog and statistic display
- Compatible with instruments with Bluetooth® Wireless technology*

H



Output cable USB to USB (804.1210) and output cable RS232 to RS232 (925.5609)

Large touchscreen 8.5" protected against liquids IP65



Fully configurable user interface allowing to define the number of displayed channels per screen

Ergonomic keyboard

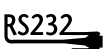

* Dongle Smart required

Digital display

D300S V2

INTERFACE | HARDWARE

- ① Touchscreen 8.5"
- ② ON/OFF button for LCD
- ③ Numeric keyboard
- ④ Navigation keyboard
- ⑤ ON/OFF switch
- ⑥ Capacitive probes inputs
- ⑦ RS-232 instrument input or PC connection ¹⁾
- ⑧ RS-485 input
- ⑨ VGA output
- ⑩ Opto-coupled digital output
- ⑪ 2 inputs for external contacts
- ⑫ RJ-45 Ethernet
- ⑬ USB Device connector
- ⑭ 6 USB Host inputs
- ⑮ 24VDC connector
- ⑯ Audio jack connector
- ⑰ RS485 connector for connecting MB-X modules

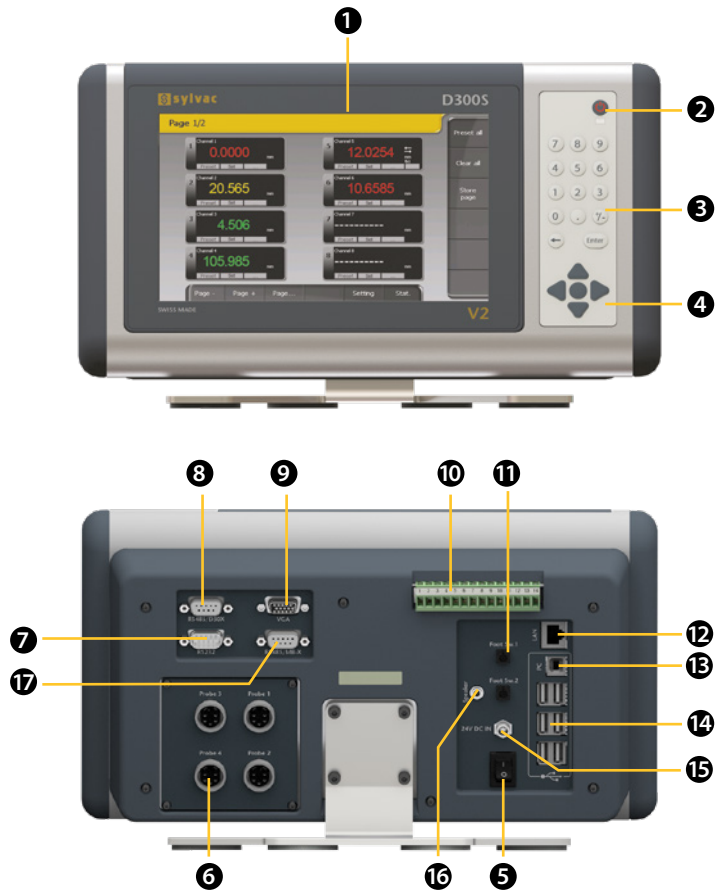

¹⁾ depends on configuration

TECHNICAL SPECIFICATIONS

	804.1300	804.1320	804.1310	804.1330	804.1340
Model	D300S-2	D300S-4	D300S		
Inputs *	2 probes / 6 USB**	4 probes / 6 USB**	M-Bus / 6 USB**	2 probes / M-Bus	4 probes / M-Bus
Max error	µm	P2 : 1.5 / P5 : 1.6 / P10 : 1.6 / P25 : 1.9	---	---	---
Max. Error ¹⁾	µm	P2 : 0.5 / P5 : 0.6 / P10 : 0.6 / P25 : 0.8	---	---	---
Repeatability	µm	P2 : 0.2 / P5 : 0.2 / P10 : 0.2 / P25 : 0.2	---	---	---
Overall dimensions	mm	330 x 175 x 77			
Weight	kg	3.3			
Case		Steel / Plastic			
Protection rating according to IEC 60529		IP40			
Output data		USB / RS232			
Programmable by PC		●			

¹⁾ Probe and unit calibrated

* Extendable to 32 probes and 12 USB instruments

** On request, all the units can be provided with M-Bus modules connectors

Digital display

D300S V2

STANDARD DELIVERY

- Unit according to technical specifications
- Table base
- External contact (foot-pedal)
- Charging unit according to country (804.4000)
- Instruction manual

APPLICATIONS



Many instruments connected to the D300S with live displayed colored values to indicate the tolerances



Multi-gauging measurement using D200S interface and D300S display



Measurement using PS17 bench Automatic detection of measuring channel and automatic switch to the right window



Multiple instruments connection through Bluetooth® wireless technology



Multiple instruments connection through M-BUS inputs



Dial gauges with Bluetooth® wireless technology connected to D300S

H

Digital display

D300S V2

POSSIBILITIES OF CONNECTION WITH ACCESSORIES

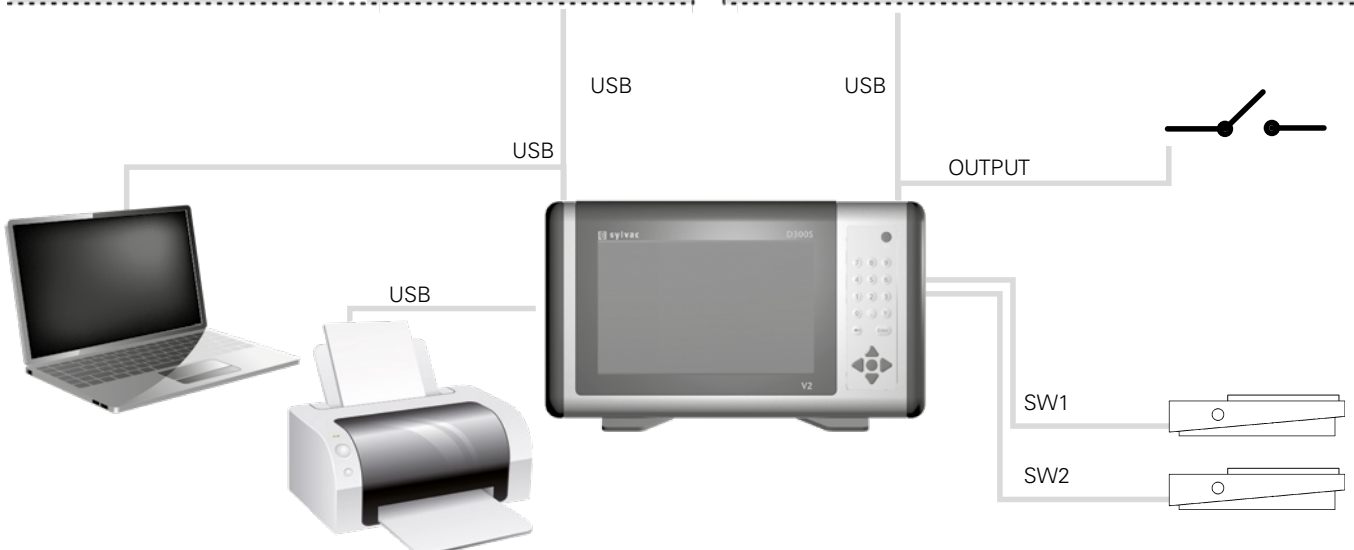
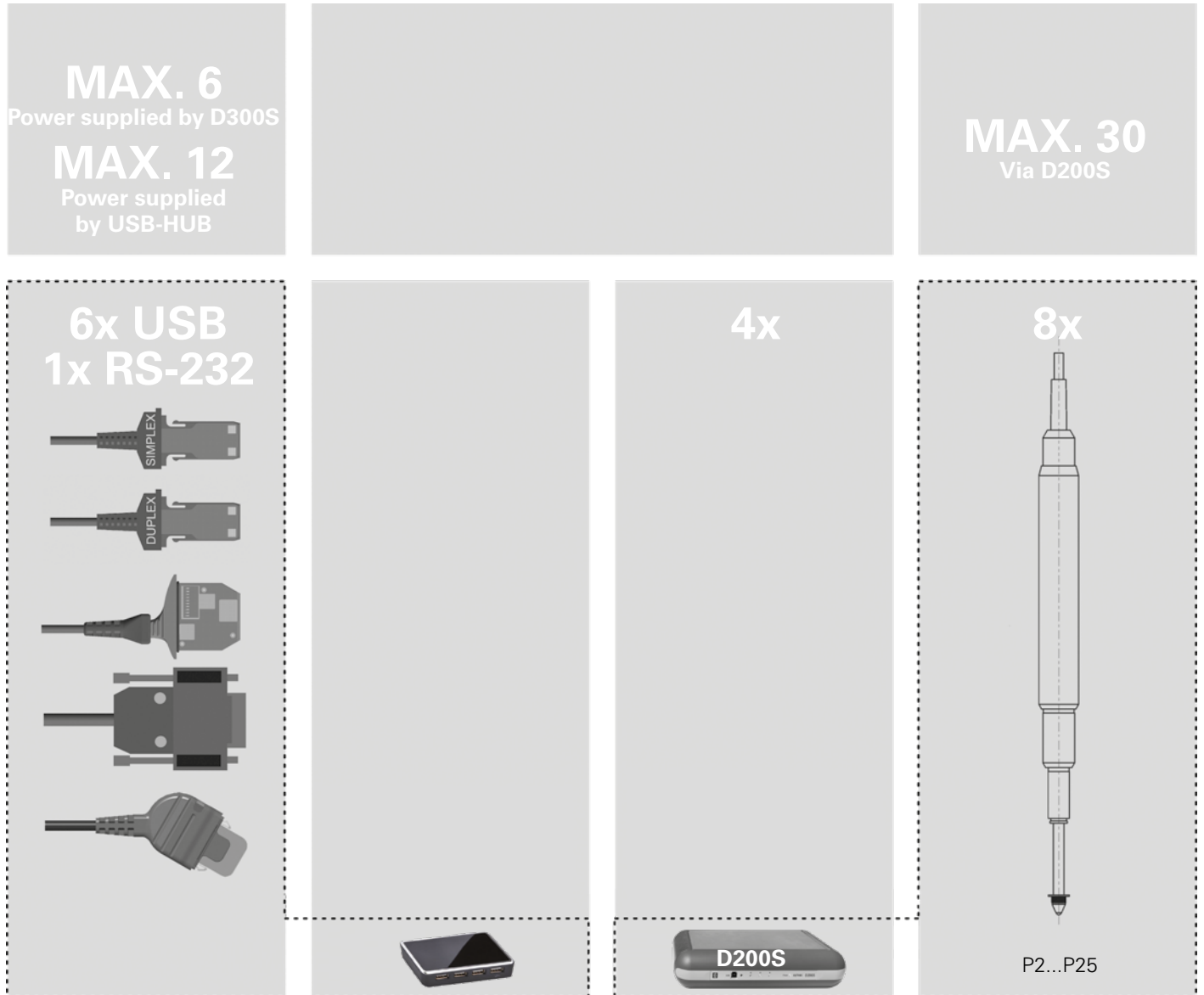

H

Digital display

D300S V2

POSSIBILITIES OF CONNECTION WITH ACCESSORIES

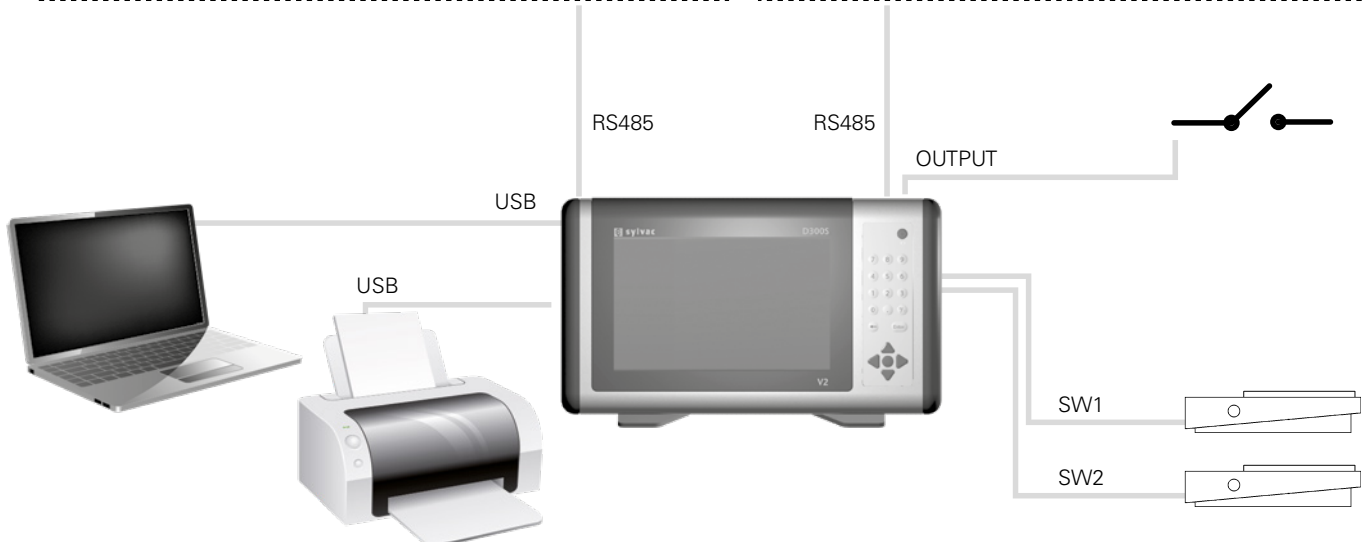
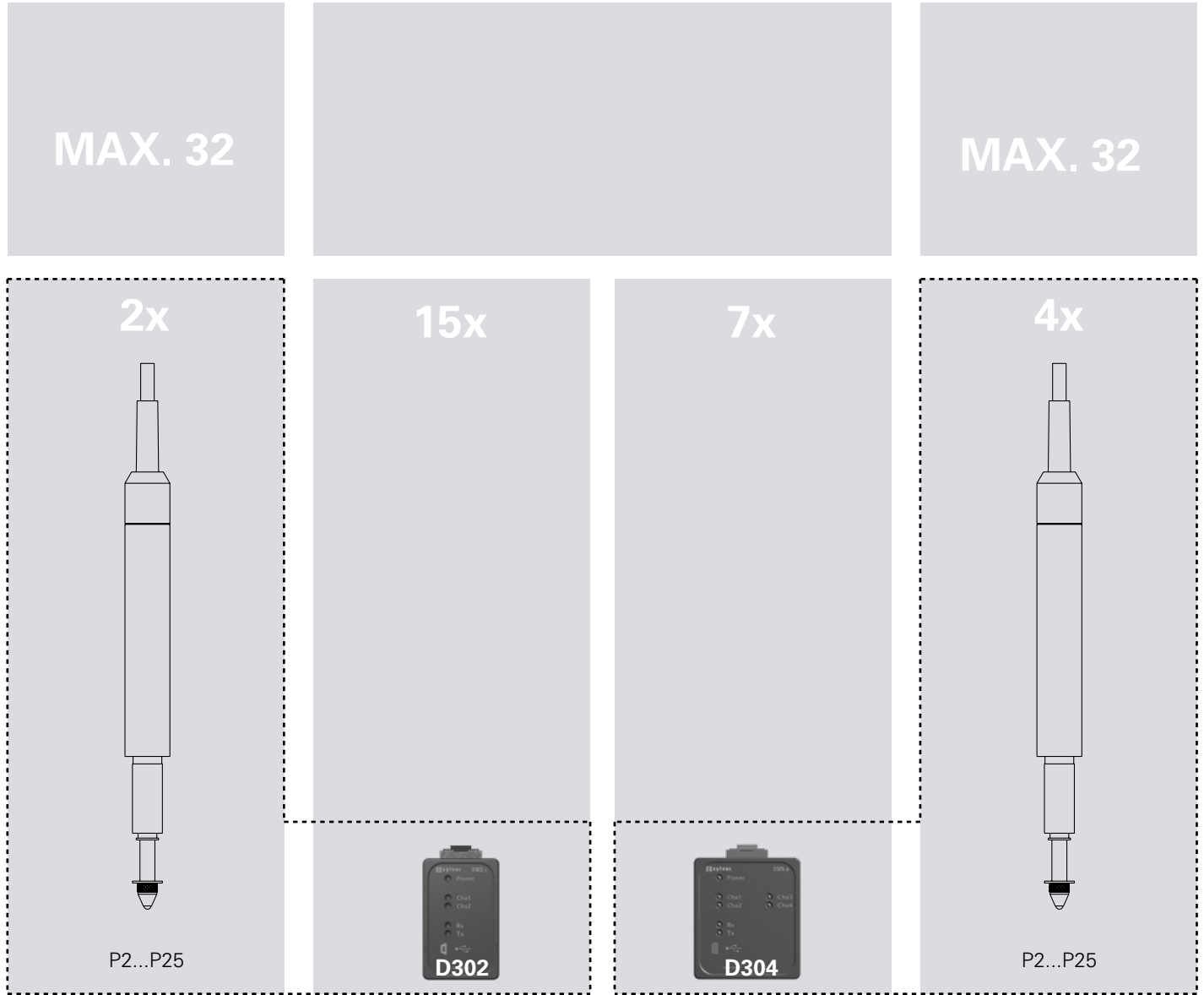

Digital display

D300S V2

POSSIBILITIES OF CONNECTION WITH ACCESSORIES

MAX. 32

Compatible with all M-BUS modules, except MB-RS, MB-AG and MB-BT

MAX. 32

2 - 8x*

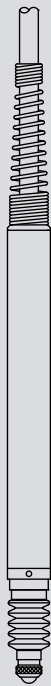

P2i / P2iP / P5i / P5iP

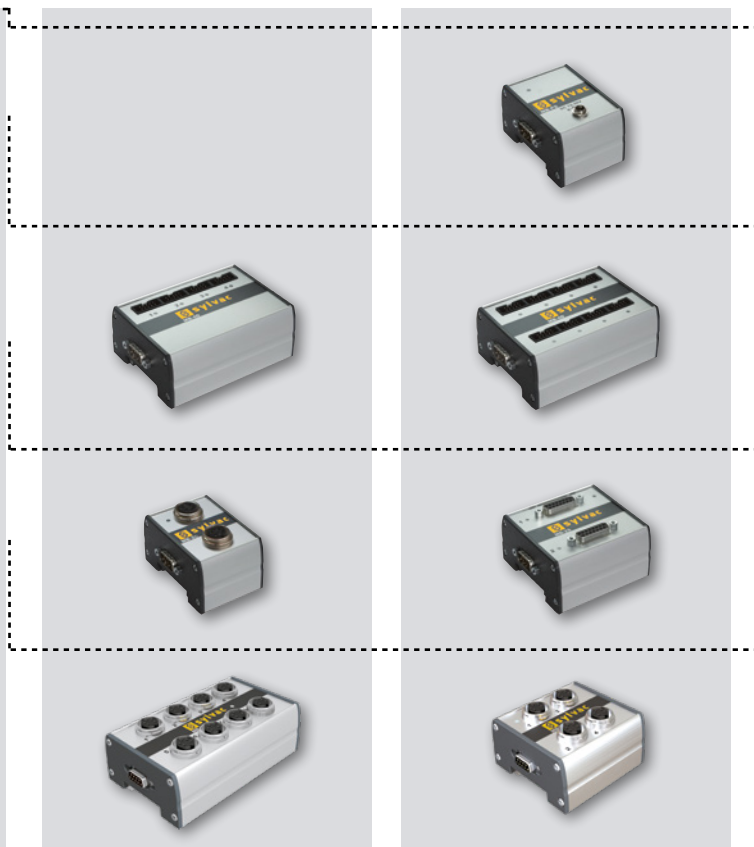

2 - 8x*



P2i / P2iP / P5i / P5iP

* Depends of the M-Bus

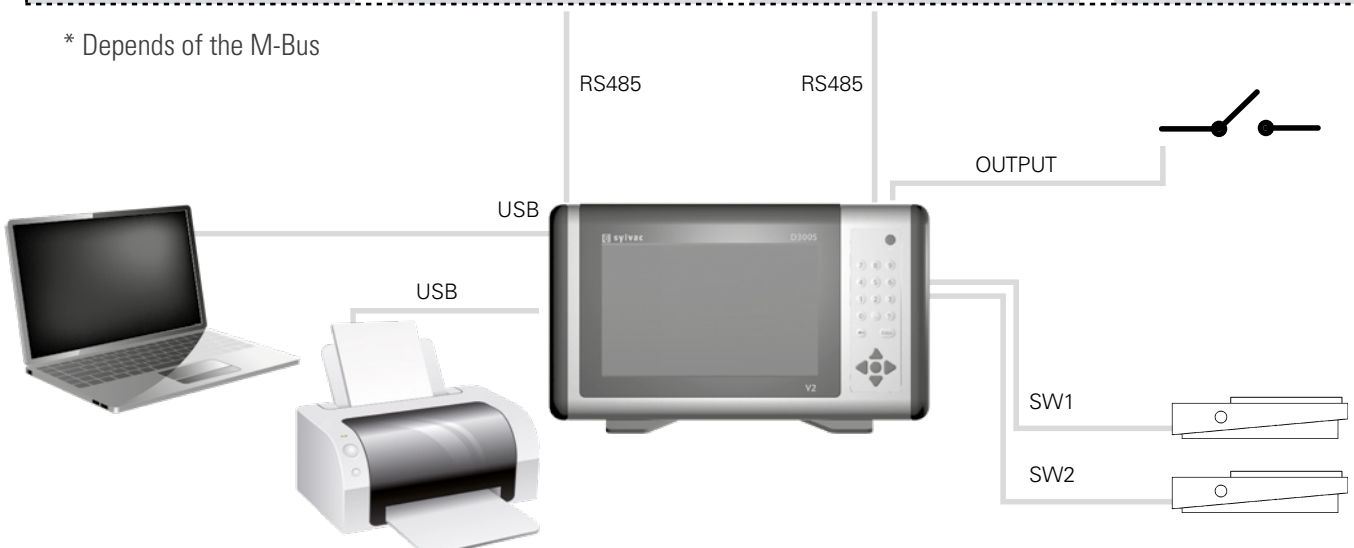

Digital display

D300S V2

POSSIBILITIES OF CONNECTION WITH BLUETOOTH® WIRELESS TECHNOLOGY

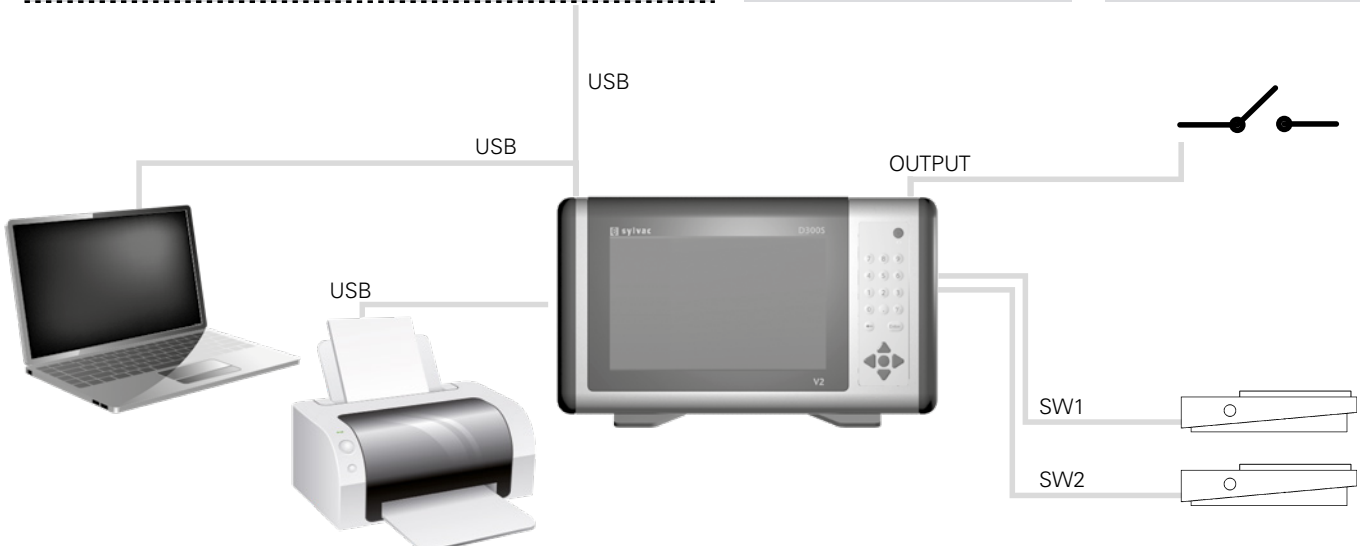
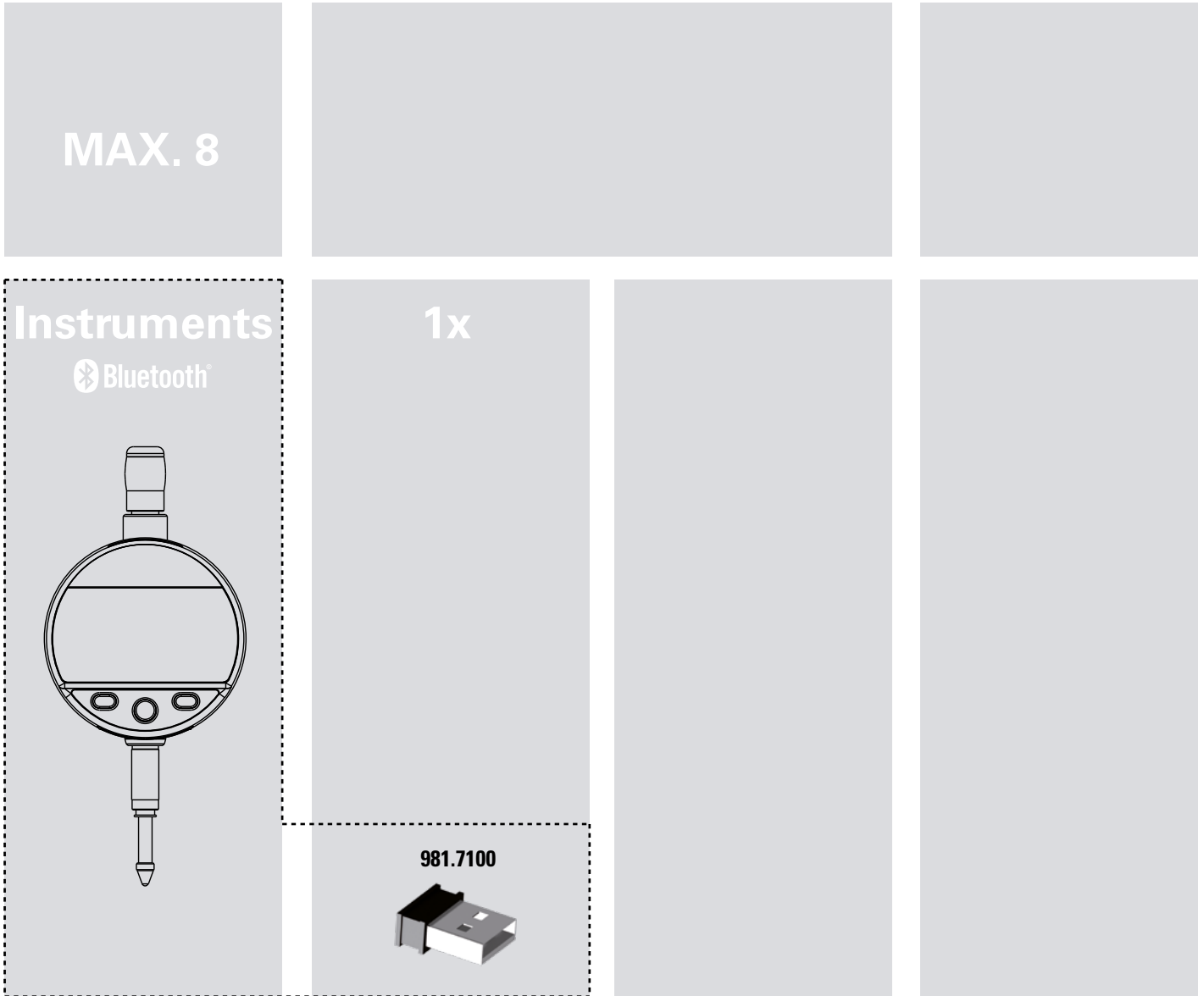

H

DESCRIPTION

- Digital multifunctional unit with 7" touch screen display
- Multi-brands compatible through M-BUS multiplexers (possibility to mix the brands)
- Designed for multigauging applications
- Up to 99 instruments connectable through M-BUS modules
- Automatic detection of connected instruments
- Storage of up to 128 different parts configurations
- Up to 30'000 measurements can be saved by configuration
- Display of up to 32 channels simultaneously (on the same screen) or distributed up to 32 pages
- Single or multi-gauging display mode
- SPC functions (run chart, pareto, histogram with Gauss curve, etc.)
- PLC functions and PLC communication protocols
- Formula editor, free combination between all instruments connected to the M-BUS
- Configurable by PC
- Ethernet connection with Modbus TCP
- Multifunction footpedal input
- User friendly interface
- Very robust construction (Aluminium)
- Table or panel mounting

Large touchscreen 7" protected against liquids IP65



Output cable USB to USB (804.1210) or RS232 (925.5609)



USB

Digital display

D400S

INTERFACE | HARDWARE

- ① Customizable display interface
- ② Aluminium body
- ③ 12VDC/30VDC Power supply
- ④ RJ-45 Ethernet TCP4
- ⑤ USB host (for usb key)
- ⑥ USB device (virtual keyboard)
- ⑦ Footswitch
- ⑧ M-bus
- ⑨ RS232

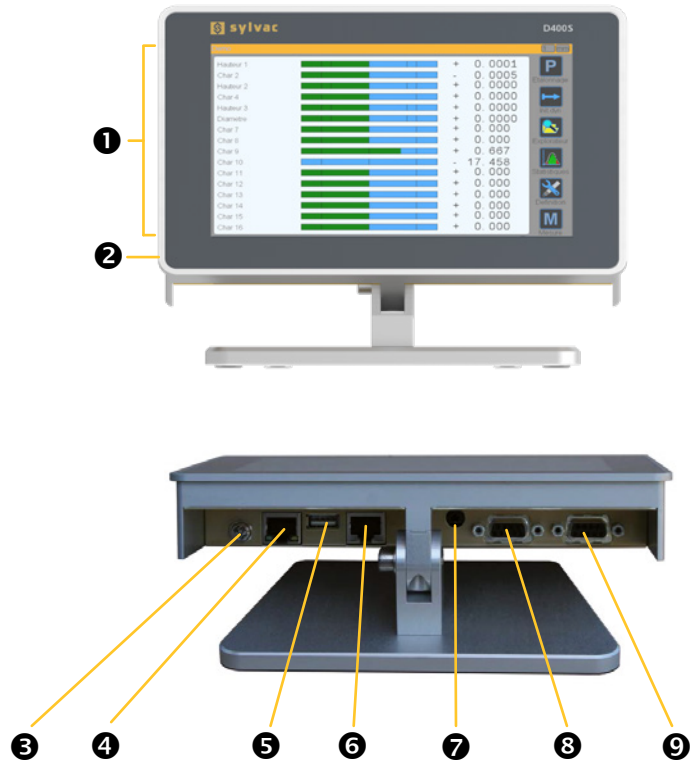

TECHNICAL SPECIFICATIONS

		804.2400
Model		D400S
Overall dimensions	mm	200x143x151.6
Weight	kg	1.3
Case		Aluminium
Protection rating according to IEC 60529		IP65 (front face)
Output data		USB / RS232
Programmable by PC		●

Digital display

D400S

STANDARD DELIVERY

- Unit according to technical specifications
- Charging unit
- Instruction manual

APPLICATIONS



Probes connection through M-BUS inputs

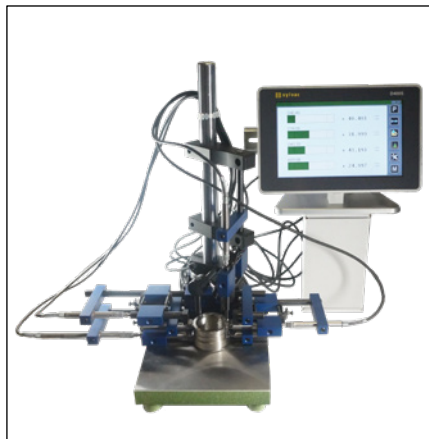

Inductive probes connection on a jig











Probes and indicators connection through M-BUS inputs

Digital display

D400S

POSSIBILITIES OF CONNECTION WITH ACCESSORIES

<p>Compatible with all M-BUS modules, except MB-RS</p>		<p>MAX.99</p>
--	--	---------------

H

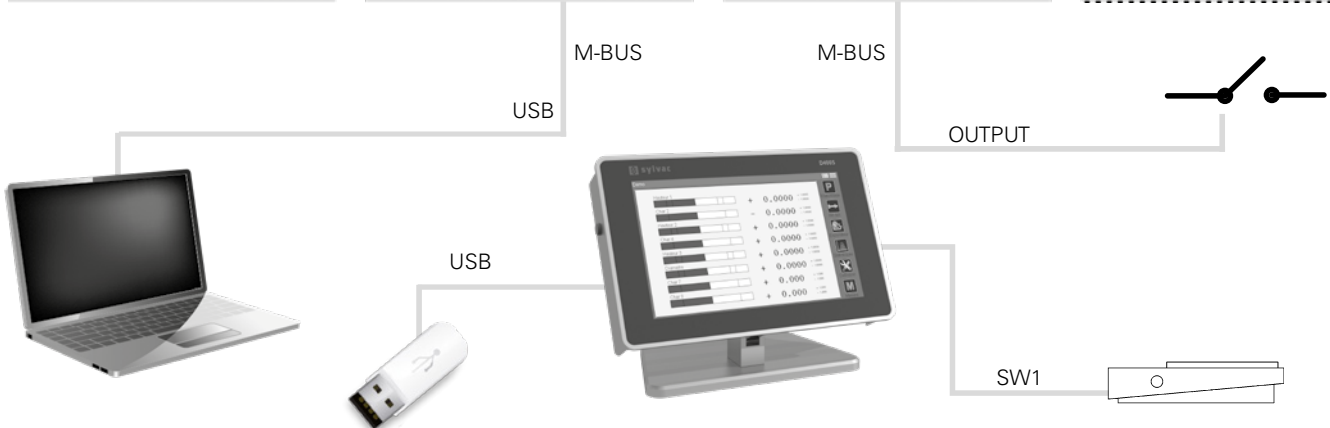

Multiplexer unit

D302 / D304

DESCRIPTION

- Multiplexing unit with 2 or 4 inputs for Sylvac probes P2 à P25
- Dynamic measurement (10 à 20 meas./Sec. according to resolution)
- Perfect solution for multi-gauging system
- Analog output for PLC connection
- Standalone use possible



Output cable RS485 to RS485 (925.5609)

Output cable mini-USB to USB (926.6001)

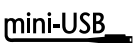
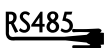

Multiplexer unit

D302 / D304

HARDWARE DESCRIPTION

- 1 LED Power
- 2 LED channel
- 3 LED RS 485 activity
- 4 USB port for PC connection
- 5 RS 485 output
- 6 Ground connector
- 7 RS 485 input
- 8 External connector
- 9 Standard clamping (DIN 35mm)
- 10 Jumpers
- 11 Analog output / 24 VDC (only version a)
- 12 Probes input
- 13 9V power supply input

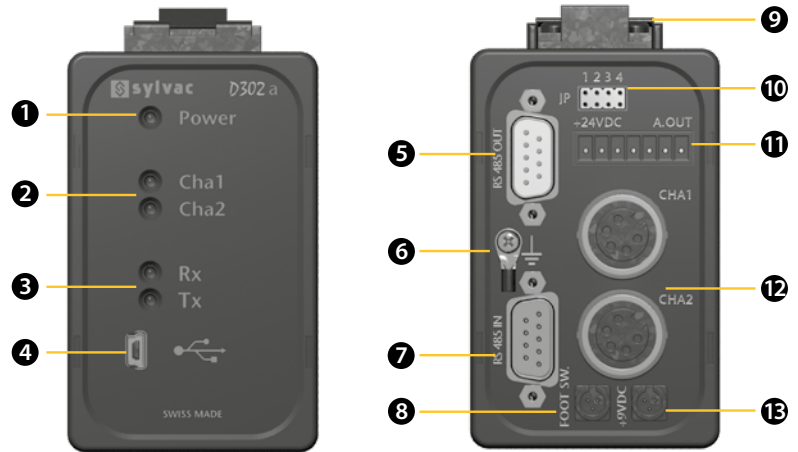

TECHNICAL SPECIFICATIONS

		804.1302	804.1303	804.1304	804.1305
Modele		D302	D302a	D304	D304a
Max error	µm	P2 : 1.5 / P5 : 1.6 / P10 : 1.6 / P25 : 1.9			
Max. Error ¹⁾	µm	P2 : 0.5 / P5 : 0.6 / P10 : 0.6 / P25 : 0.8			
Repeatability	µm	P2 : 0.2 / P5 : 0.2 / P10 : 0.2 / P25 : 0.2			
Overall dimensions	mm	95 x 88 x 55		95 x 88 x 77	
Weight	kg	0.3			
Case		Aluminium profil / plastic TA 6			
Protection rating according to IEC 60529		IP40			
Output data		USB / RS 485			
Programmable by PC		•			
Analog output signal			-10V ... +10V		-10V ... +10V

STANDARD DELIVERY

- Unit according to technical specifications
- Feet (pair)
- RS232/RS485 cable
- Charging unit according to country (904.4200)
- Instruction manual

Multiplexer unit

M-Bus

DESCRIPTION

- Multiplexer units allowing to connect different kind and brands of instruments to our D300S V2, D400S and Sylcom
- Possibility to connect and mix different brands together
- RS485 based protocol
- The different units can be mounted on a DIN rail
- Robust construction



RS485

HARDWARE DESCRIPTION

- 1 Probes input
- 2 M-Bus input
- 3 M-Bus output
- 4 DIN mounting groove
- 5 LED / Power module
- 6 DIN rail

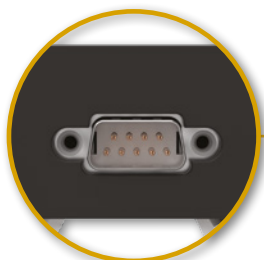

Output cable RS485 to RS485 (925.5609)

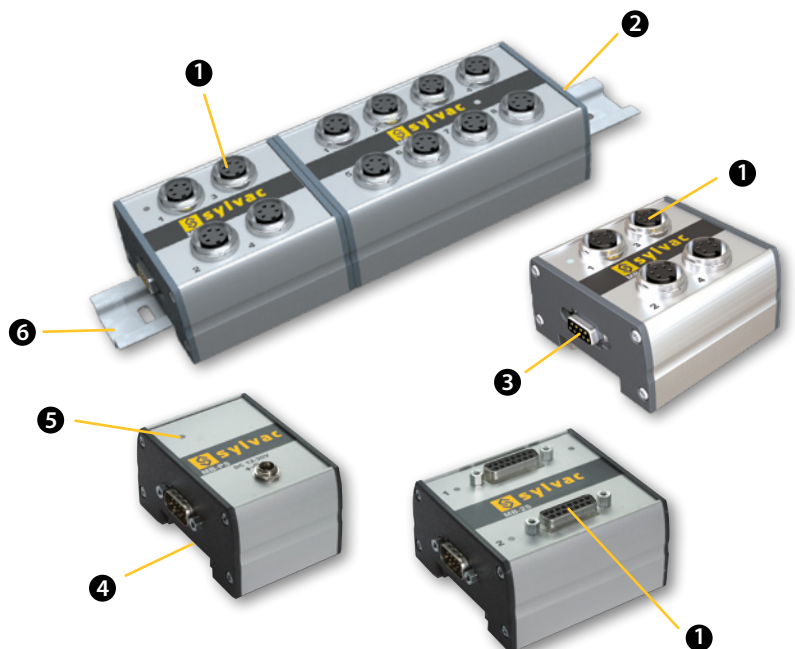

Multiplexer unit

M-Bus

TECHNICAL SPECIFICATIONS

	804.2104	804.2108	804.2122	804.2114	804.2118	804.2105
Modele	MB-4C	MB-8i	MB-2S	MB-4D	MB-8D	MB-4P
Instrument type	Sylvac capacitive probes	Inductive ¹⁾	Heidenhain probes (11µA/1VPP)	Digimatic		Probes P12D
Compatibility	D300S & D400S					
Dimensions (L x h x w) mm	107x42x74	131x44x74	82x43x74	107x39x74	107x39x74	107x42x74
Weight kg	0.2	0.3	0.2	0.2	0.2	0.2
Inputs	4	8	2	4	8	4
Case	Anodized aluminium profile					
Output data	RS 485					

¹⁾ Half-bridge: see www.sylvac.ch for information on compatibility

	804.2130	804.2140	804.2160	804.2170	804.2180	804.2190
Modele	MB-IO	MB-PS	MB-RS	MB-TP	MB-BT	MB-AG
Instrument type	PLC I/O	Power-Supply	Computer	Temperature sensor input PT100 and Thermocouple	Instruments with Bluetooth® wireless technology	Plug gauges and Air gauges
Compatibility	D300S & D400S			D400S		
Dimensions (L x h x w) mm	82x39x74	52x42x74	82x39x74	52x51x74	52x39x74	52x64x74
Weight kg	0.2	0.2	0.2	0.1	0.1	0.15
Inputs	8	12-30 VDC	254	1 / 1	8	1
Case	Anodized aluminium profile					
Output data	RS 485					



MB-4C



MB-8i



MB-2S



MB-4D



MB-8D



MB-4P



MB-IO



MB-PS

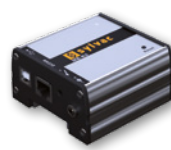

MB-RS



MB-TP



MB-BT



MB-AG

STANDARD DELIVERY

- M-Bus module according to technical specifications
- Instruction manual

Multiplexer unit

APPLICATIONS



Probes connection through M-BUS inputs



Probes connection on PC through MB-RS



Probes and indicators connection through M-BUS inputs



Probes connection on a D300S through D302 multiplexer units



Digimatic instruments connected to a MB-4D





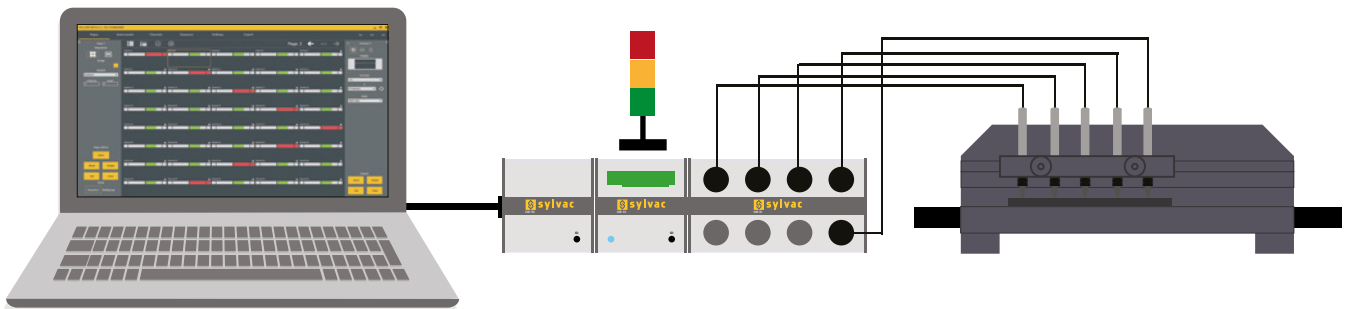









Probes connected to a MB-8i



Connection of probes via Mbus on Sylcom

Display units

ACCESSORIES

		D50S	D62S	D70S	D70H	D70I	D70A	D200S	D300S	D302 D304	D400S	P12D
	904.1108 D108-additional 8 input unit for probes											
	904.1112 D110V-control unit with 16 vacuum outputs							•	•			
	904.4200* Charging set 100-240V / 9V	•	•					•		•		
	904.4205 EUR cable, included in 904.4200	•	•					•		•		
	904.4204 UK cable, included in 904.4200	•	•					•		•		
	904.4203 USA/JPN cable, included in 904.4200	•	•					•		•		
	904.4201 CH cable, included in 904.4200	•	•					•		•		
	804.4000* Charging set 100-240V / 24V								•		•	
	904.4001 EUR cable included in 804.4000								•		•	
	904.4003 UK cable included in 804.4000								•		•	
	904.4002 USA/JPN cable included in 804.4000								•		•	
	804.4010* Charging set 100-240V / 24V											
	804.4011 EUR cable included in 804.4010											
	804.4013 UK cable included in 804.4010										•	
	804.4012 USA/JPN cable included in 804.4010											
	904.4101 External contact (footpedal)	•	•	•				•	•	•	•	
	904.4102 Footpedal (jack)				•	•	•					
	926.7022 Footpedal Smart							• ¹⁾				
	926.7020 Footpedal USB	PC only										
	926.7021 Footpedal USB robust	PC only										
	904.6001 Dust cover								•			
	804.1211 Connection cable D200S - D110/V							•				

H

¹⁾ Dongle Smart required

²⁾ The right country cable, depending on the delivery location, will be delivered with 904.4200, 804.4000 and 804.4010.

Display units

ACCESSORIES

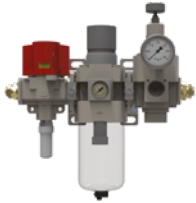

		D50S	D62S	D70S	D70H	D70I	D70A	D200S	D300S	D302 D304	D400S	P12D
804.2104	MB-4C								•		•	
804.2108	MB-8i								•		•	
804.2122	MB-2S								•		•	
804.2114/18	MB-4D & MB-8D								•		•	
804.2130	MB-IO								•		•	
804.2140	MB-PS								•		•	
804.2160	MB-RS											
804.2170	MB-TP								•		•	
804.2180	MB-BT										•	
804.2190	MB-AG										•	
804.2105	MB-4P											•
804.2203	Air kit						•					
804.2202	Bracket for panel mounting						•					
804.4101	Restrictor Ø 0.3mm						•				•	
804.4102	Restrictor Ø 0.4mm						•				•	
804.4103	Restrictor Ø 0.5mm						•				•	
804.4104	Restrictor Ø 0.7mm						•				•	
804.4105	Restrictor Ø 0.9mm						•				•	